



# **TECHNICAL SPECIFICATION**

**NCEM C14-100**

**June 2022**

**General Technical  
Specification for Building's  
Low Voltage Electrical  
Installations**

## Contents

1	Introduction .....	4
2	Outline.....	5
2.1	Objective.....	5
2.2	Application field .....	5
2.3	Definitions.....	5
2.3.1	Low voltage electrical installation .....	5
2.3.2	Distribution network .....	6
2.3.3	Pothead .....	6
2.3.4	Branch line .....	6
2.3.5	Connection point to network.....	6
2.3.6	Collective installation.....	6
2.3.7	Building main low voltage switchboard.....	7
2.3.8	Common section .....	7
2.3.9	Main collective switchboard.....	7
2.3.10	Collective line .....	7
2.3.11	Branch collective line.....	7
2.3.12	Collective line distribution board.....	7
2.3.13	Service-entrance line.....	8
2.3.14	Meter box .....	8
2.3.15	Meter board.....	8
2.3.16	Box for current transformers .....	8
2.3.17	Compartment for current transformers.....	8
2.3.18	Service circuit breaker.....	8
2.3.19	Origin of a low voltage electrical installation.....	9
2.3.20	Electrical installation.....	9
2.3.21	Distinct electrical installation .....	9
2.3.22	Emergency installation.....	9
2.3.23	Required power.....	9
3	General principles .....	10
3.1	Electrical energy supply .....	10
3.2	Execution of electrical installations .....	11
3.3	Maintenance of electrical installations.....	11
3.4	Operation of electrical installations .....	12
4	Electrical power supply conception.....	12
4.1	Outlines.....	12

4.2	Network connection points .....	12
4.3	Calculation of required power .....	13
4.4	Collective installations .....	18
4.5	Service-entrance line from collective installation .....	22
4.6	Energy meter .....	23
5	Dimensioning of electrical wiring .....	24
5.1	Types of electrical wire .....	25
5.1.1	Insulated conductors and cables .....	25
5.1.2	Tubes .....	26
5.1.3	Ducts .....	29
5.2	Dimensioning of collective lines .....	30
5.3	Independent collective lines .....	33
5.4	Protective conductor .....	33
5.5	Continuity of collective lines .....	35
5.6	Voltage drop .....	35
5.7	Protection against overcurrent .....	36
5.8	Protection against overload .....	37
5.9	Protection against short-circuit .....	38
6	Electrical symbols .....	40
ANNEX 1	.....	41
ANNEX 2	.....	42
ANNEX 3	.....	43
ANNEX 4	.....	47
ANNEX 5	.....	54
ANNEX 6	.....	60
ANNEX 7	.....	63
ANNEX 8	.....	70
ANNEX 9	.....	72
ANNEX 10	.....	74
ANNEX 11	.....	81
ANNEX 12	.....	82

## 1 Introduction

1. Regulamento Geral de Construção Urbana, approved by Decree-Law No. 79/85/M on 21<sup>st</sup> of August, contains various provisions governing the analysis and approval process of civil construction projects carried in Macau, which prescribes in particular:

- All new buildings should be equipped with electrical installations, including those used to supply their common services, service-entrance lines and collective installations;
- The application of construction license shall be submitted with an electrical installation project, and the approval of the license will depend on the approval of the mentioned project;
- The approval process of construction license shall contain the comments issued by CEM.

2. For the implementation of approval process of electrical installation projects, the following items were defined between DSSCU and CEM:

- CEM issues technical advice and supervises the supply and distribution of electrical energy in the building's common area up to and including the energy meter;
- DSSCU issues technical advice regarding the installation excluding the building's common area and supervises the installations from a safety point of view;
- Establishment of electrical installations shall comply with the provisions of the regulations in force in Macau. Otherwise, it shall comply with the applicable parts of IEC and CENELEC standards;
- Keep using CEM technical specifications and extend them when necessary, since these complement the regulations and detail the specifications of the approved material and equipment.

3. Despite the decisive step that was then taken, the influence of Macao's development on the dynamics of the urbanization of the territory requires a new and ambitious approach for a convenient design and execution of electrical installations, not only in terms of security and technology, but also from a socio-economic point of view.

4. Therefore, the normative document which is now published is intended to reveal current rules followed by CEM in issuing opinions on building's low voltage electrical installations, under Art. 6 of Decree-Law No.79/85/M of 21<sup>st</sup> of August, taking into consideration:

- Knowledge and experience of electrical installations acquired by CEM, in the indispensable aspect of security of people, operation, and quality of service.
- Inconveniences that may arise for public, arising from any repairing work or expansion of networks take place in the future.

## **2 Outline**

### **2.1 Objective**

The purpose of this document is to establish general technical requirement observed in the design of building's low voltage electrical installations, in which the electricity is supplied by CEM.

### **2.2 Application field**

This document applies to the energy supply of new collective installations and building's service-entrance lines supplied from distribution network or customer substation within CEM network, and renovation and modification of existing electrical installations.

In duly justified cases, the provisions of this document may be waived if it is not practicable in application. Alternative solutions shall be subject to CEM for prior approval.

### **2.3 Definitions**

#### **2.3.1 Low voltage electrical installation**

Installation in which the effective or nominal voltage does not exceed the following values:

- In alternating current: 1000 V
- In direct current: 1500 V

### **2.3.2 Distribution network**

Low voltage electrical installation for electrical energy transmitting from transformer substation or generating station, consisting of main lines and branch lines.

### **2.3.3 Pothead**

Switchboard where the branch lines ends, and belongs to it, which contains as a rule switching devices and overcurrent protection devices for collective installations or service-entrance lines connecting to downstream.

### **2.3.4 Branch line**

Electric line without any extension, which is part of the transformer substation switchboard, distribution box or board of a generating station, and terminates at pothead, main low voltage switchboard, main collective switchboard or service circuit breaker of an electrical installation.

### **2.3.5 Connection point to network**

A point which defines the interface between the building electrical installation and CEM distribution network, which corresponds to:

- The outgoing connectors of the service overcurrent protection device or switching device of the pothead.
- The incoming connectors of the service circuit breakers of the building's main collective switchboard or the building's main low voltage switchboard, supplied directly from the distribution network or transformer substation.
- The incoming connectors of service circuit breakers of electrical installation, supplied directly from distribution network or transformer substation.

### **2.3.6 Collective installation**

Electrical installation established, as a rule, inside a building to supply electrical installations operated by different entities, consisting of common section, main low voltage switchboard, main collective switchboard, collective line and collective line distribution box. The collective installation begins at the pothead or main collective

switchboard or main LV switchboard and terminates at the service-entrance line of the customer installation.

### **2.3.7 Building main low voltage switchboard**

Switchboard which includes overcurrent protection devices of electrical wiring for main collective switchboard, collective installation and service-entrance line, normally connected to a transformer substation.

### **2.3.8 Common section**

Electric line for collective installation supplying from pothead and terminating at main collective switchboard.

### **2.3.9 Main collective switchboard**

Switchboard where the overcurrent protection of risers or entrances are installed and which can be supplied by: pothead (the cable that connects to the pothead or main switchboard is a part of the main collective switchboard), network cable or branch line, or low voltage main switchboard (the cable that connects to the low voltage main switchboard is a part of the main collective board)

### **2.3.10 Collective line**

Circuit for collective installation which begins at the main low voltage switchboard or main collective switchboard.

### **2.3.11 Branch collective line**

Circuit for collective installation that begins at the distribution box of other collective line.

### **2.3.12 Collective line distribution board**

Board installed in a collective line or branch collective line for connection of service-entrance line or other collective line, with or without overcurrent protection devices.

### **2.3.13 Service-entrance line**

Low voltage electric line between:

- A collective line distribution box and the origin of an electrical installation
- A main collective switchboard and the origin of an electrical installation
- A pothead that supplies an electrical installation and the origin of that electrical installation.
- A main low voltage switchboard and the origin of an electrical installation.
- A transformer substation that supplies an installation and the origin of that installation.

### **2.3.14 Meter box**

Panel enclosure, existing in service-entrance line, for installation of energy metering equipment.

### **2.3.15 Meter board**

Panel equipped with supporting structure, existing in service-entrance line, for installation of energy metering equipment.

### **2.3.16 Box for current transformers**

Box existing in service-entrance line, for installation of low voltage current transformers, used for energy metering.

### **2.3.17 Compartment for current transformers**

Compartment in the main switchboard, for installation of low voltage current transformers, used for energy meter.

### **2.3.18 Service circuit breaker**

Cutting and protection device interleaved at service-entrance line, on downstream side of metering equipment and intended to limit the required power for electrical installation.



### **2.3.19 Origin of a low voltage electrical installation**

The position at which electrical energy is delivered to an electrical installation which corresponds to the outgoing connectors of the service circuit breaker.

### **2.3.20 Electrical installation**

Low voltage electrical installation designed to enable its users to use electrical energy by transforming it into another form of energy.

### **2.3.21 Distinct electrical installation**

Electrical installations without any connection with independent service-entrance lines.

### **2.3.22 Emergency installation**

Installation intended to provide support to established facilities in locations where a power outage may lead to dangerous situations or cause personal and material damage.

### **2.3.23 Required power**

A value of power of the electrical installation to which the connection between supply and user should be established and the upstream network shall be capable supplying.

### **3 General principles**

#### **3.1 Electrical energy supply**

The power supply in low voltage to building's electrical installations can be realized as:

- From the low voltage public distribution network, for requested power up to 70 kVA.
- From transformer substation installed in building, for requested power higher than 70 kVA.
- In case the requested power exceeds 70 kVA but does not exceed 350 kVA, CEM may allow power supply from the existing low voltage distribution network, if possible.
- In case the requested power exceeds 350 kVA, a customer substation needs to be built in the building and power supply from medium voltage network.

The supply voltage of low voltage network shall be 230/400 V, with tolerances between -10% and +5%, measured at the supply point of the electrical installation.

Buildings with only one electrical installation, operated by one single entity, shall be carried out by service-entrance lines, branch lines or line leading to CEM network.

Electrical installations operated by different entities, related to the building's autonomous units, shall normally be carried out by means of service-entrance line from the public collective installation of the building.

Annex 5 provides typical examples of power supply of electrical installations in buildings from CEM network, indicating their characteristics and application scope.

### **3.2 Execution of electrical installations**

CEM is responsible for all work relating to supply of building electrical installations, on upstream side of connection point to the network, namely:

- Supply and installation of equipment of customer substation in a suitable place provided by the building project owner.
- Execution of the branch line of pothead, main collective switchboard or main building low voltage switchboard.
- Supply and installation of electricity meters and accessories

The building project owner is responsible for providing the building electrical installations, on upstream and downstream sides of the connection point to the public power network, namely:

- Civil construction of customer substation according to the civil design provided by CEM (upstream).
- Installation of supply equipment, pothead will be provided by CEM (upstream).
- Supply and installation of electrical wiring supplying from building supply point ( main LV switchboard or pothead or main collective switchboard), all appliances and equipment related to the building's collective installation, service-entrance line for all the residential, commercial and parking lot premises and communal installation (downstream).

### **3.3 Maintenance of electrical installations**

Charges for maintenance and renovation of electrical installations, on upstream side of connection point, are the responsibility of CEM.

Building's owner is responsible for all maintenance, repairing and restoration of the electrical installations on downstream side of supply point.

### **3.4 Operation of electrical installations**

CEM exercises the right to operate the building's electrical installations, on downstream side of supply point to the network and up to the origin of the electrical installations, relating to collective installation and service-entrance line, with a view to:

- Avoid any disturbance in the operation of distribution network or in other installations.
- Ensure the safety of people and goods.
- Prevent the illegal or fraudulent use of electricity.

## **4 Electrical power supply conception**

### **4.1 Outlines**

Power supply of a building should be designed in cooperation between CEM and the designers involved in the construction project, in finding the best solutions which shall take into account the following aspects:

- Integration of the electricity supply with the other installations in the building
- Applicable standardization and how they determine the fitting of electrical equipment installation.
- Use of standardized components and equipment, which facilitates the design and guarantee an efficient operation of electrical installations.
- Adequate choice of spaces in construction that ensures a safe, flexible and sustainable use of electrical installations.
- Electrical facilities must comply with anti-flood design requirements, as presented in Annex 12.

### **4.2 Network connection points**

The characteristics of the power supply points to CEM distribution network should be determined according to the requested power demand.

A network power supply point can be considered as individual or collective if supplies a single or various electrical installations. For buildings supplied from the low voltage distribution network, it should normally be provided one single grid connection point. For buildings supplied from customer substation in the building, the number of grid

connection points provided shall be normally equal to the number of transformers of the customer substation in the building.

### **4.3 Calculation of required power**

The values of power per unit area (kVA/m<sup>2</sup>) shall be determined according to the gross area of the electrical installation location, adjusted to the values of required power indicated in Table 1.1.

The design of the electrical installation according to the minimum permitted power should conform to the standardized subscribed demand levels indicated in Table 1.2.

The total power at any power supply point to the electricity network shall be determined by reference to the total power of electrical installations and the application of respective simultaneity coefficients Ks in Table 1.3.

Table 1.1 – Minimum design load by premises type

Premises type	Minimum attributed load
<b>Residential Premises</b>	
1.1 Apartments/Flats <sup>[**]</sup>	
≤60m <sup>2</sup>	20.7 kVA
>60-100m <sup>2</sup>	34.5 kVA
>100-125m <sup>2</sup>	41.4 (34.5) kVA [*]
>125-188m <sup>2</sup>	55.2 (34.5) kVA [*]
>188-210m <sup>2</sup>	69 kVA
>210m <sup>2</sup>	0.330 kVA/m <sup>2</sup>
<b>Commercial Premises</b>	
2.1 Shops, Restaurants and similar catalogues at ground floor with direct access to public road	
≤60m <sup>2</sup>	20.7 kVA
>60-105m <sup>2</sup>	34.5 kVA
>105-125m <sup>2</sup>	41.4 (69) kVA [*]
>125-165m <sup>2</sup>	55.2 (69) kVA [*]
>165-200m <sup>2</sup>	69 kVA
>200m <sup>2</sup>	0.330 kVA/m <sup>2</sup>
2.2 Shops, offices and similar catalogues (e.g. shopping mall) allocate in a building without central air conditioner	
≤65m <sup>2</sup>	13.8 kVA
>65-95m <sup>2</sup>	20.7 kVA
>95-160m <sup>2</sup>	34.5 kVA
>160-195m <sup>2</sup>	41.4 (69) kVA [*]
>195m <sup>2</sup> -25,000m <sup>2</sup>	0.210 kVA/m <sup>2</sup>
Over 25,000m <sup>2</sup>	0.160 kVA/m <sup>2</sup>

2.3 Shops, offices and similar catalogues (e.g. shopping mall) allocate in a building with central air conditioner	
≤65m <sup>2</sup>	11.5 kVA
>65-85m <sup>2</sup>	13.8 kVA
>85-125m <sup>2</sup>	20.7 kVA
>125-210m <sup>2</sup>	34.5 kVA
>210m <sup>2</sup> -25,000m <sup>2</sup>	0.160 kVA/m <sup>2</sup>
Over 25,000m <sup>2</sup>	0.120 kVA/m <sup>2</sup>
2.4 Social facilities	0.160 kVA/m <sup>2</sup>
2.5 Building common areas	
With lift	34.5kVA/lift
Without lift	3.4kVA
2.6 Building parking common areas	0.008 kVA/m <sup>2</sup> , not including ventilation system and EV charging
Light electric vehicle parking space [***]	6.9 kVA / parking space
<b>Industrial Premises</b>	
3.1 Factories	0.200 kVA/m <sup>2</sup>

[\*] The new standardized subscribed demand levels of 41.4 kVA and 55.2 kVA are subject to the revised version of Administrative Regulations No. 11/2005. The power levels in brackets should be used before revision.

[\*\*] The minimum design load of economic housing and public housing units to be decided by the relevant government departments, regardless of the area, but must meet the following requirements: i) The design of public electrical installations meets the demand of 20.7 kVA; ii) The size of the service-entrance line is VD40 + 3x16 mm<sup>2</sup>.

[\*\*\*] The car parks in the new residential and commercial development projects should have basic EV charging infrastructures including cable trays, main switchboards and metering systems installed and reserve power capacity for each parking space.

Table 1.2 - Standardized subscribed demand levels

Standard Demand Level (kVA)	No. of phases	Supply voltage (V)	Circuit breaker rating (A)
3.4	Single Phase	230	16
6.9	Single Phase	230	32
11.5	Single Phase	230	50
13.8	Three Phase	230/400	3x20
20.7	Three Phase	230/400	3x32
34.5	Three Phase	230/400	3x50
41.4 (*)	<b>Three Phase</b>	<b>230/400</b>	<b>3x60</b>
55.2 (*)	<b>Three Phase</b>	<b>230/400</b>	<b>3x80</b>
69	Three Phase	230/400	3x100
100	Three Phase	230/400	3x150/160
130	Three Phase	230/400	3x200
170 (*)	<b>Three Phase</b>	<b>230/400</b>	<b>3x250</b>
200	Three Phase	230/400	3x300/320
270	Three Phase	230/400	3x400
340	Three Phase	230/400	3x500
410	Three Phase	230/400	3x600/630
550	Three Phase	230/400	3x800
690	Three Phase	230/400	3x1000
860 (*)	<b>Three Phase</b>	<b>230/400</b>	<b>3x1250</b>
1030	Three Phase	230/400	3x1500/1600
1380	Three Phase	230/400	3x2000
1600	Three Phase	230/400	3x2500

(\*) New standardized subscribed demand levels are subject to the revision of Administrative Regulation no. 11/2005.



Table 1.3 – Coincident factors for residential, commercial and industrial premises.

Number of downstream premises	Coincident factor (Ks)
<b>Residential Premises</b>	
1.1 Apartments/Flats	
≤4	1.00
5 to 9	0.69
10 to 14	0.50
15 to 19	0.38
20 to 24	0.34
25 to 29	0.31
30 to 34	0.29
35 to 39	0.27
40 to 49	0.26
≥50	0.25
<b>Commercial Premises</b>	
2.1 Shops, Restaurants and similar facilities at ground floor with direct access to public road	1.00
2.2 Offices or similar facilities within building	
≤14	1.00
15 to 30	0.87
30 to 40	0.78
40 to 50	0.70
>50	0.63
2.3 Social facilities	1.00
2.4 Building common areas	1.00
2.5 Building parking areas	1.00
<b>Industrial premises</b>	
3.1 Factories	1.00
<b>Car Park premises</b>	
4.1 Light electric vehicle parking space	
≤10	1.00
11 to 40	0.80
41 to 150	0.50
151 to 1000	0.40
>1000	0.30

#### **4.4 Collective installations**

As a rule, all individual service-entrance lines in the same building shall be supplied from the main collective switchboard or main low voltage switchboard.

Buildings with electrical installations operated by different entities shall be equipped with a collective installation for the power supply of related electrical installations.

A building's collective installation should be established, as a rule, inside the building, in common areas for public usage (entrance lobby, stairs, stairs landing, corridors, technical corridors created for this purpose, parking lots), taking into account the supply point of the building's common services and the constraints imposed by civil construction and existence of other installations (water, sewage, gas, waste disposal, elevators, etc.), and the accessibility to the collective installation on all floors should be always ensured.

The network configuration of a collective installation, on downstream side of main connection point for low voltage supply of building's electrical installations, shall be chosen as:

- To guarantee the feasibility of operation, security of electricity supply and less energy loss in transmission.
- To enable a number of customer substations for the supply of electrical energy to the building, determined according to the size, number and situation of load concentration, and located as close as possible to the highest load concentration points.

In building with power supply from low voltage distribution network, the collective installation shall be developed from a main collective switchboard, installed inside the building in an appropriate position, as close as possible to normal access and the respective connecting point (pothead, if existent).

In buildings with power supply from customer substation located in a building, with power not exceeding 690 kVA, the collective installation shall be supplied from main low voltage switchboard, installed inside the building in a suitable position, as close as possible to normal access and customer substation.

In buildings with power supply from customer substation located in a building, with power demand greater than 690 kVA, the collective line shall be supplied from the main low voltage switchboard, installed inside the building, in the customer LV electrical room and suitable position, as close as possible to normal access and customer substation.

In buildings with large a horizontal area, consisting for example of podium and several blocks, with required power greater than 3200 kVA, the collective installation shall be supplied from more than one main low voltage switchboard, in order to achieve a decentralized power supply to the building.

The electric energy supply of premises for complementary functions, such as those relating to car parks, shops, cafes, restaurants and workshops, shall be supplied from an independent collective line or directly from a main collective switchboard or main low voltage switchboard.

Building blocks with requested power demand higher than 130 kVA shall be provided of main collective switchboard supplied from a main low voltage switchboard, installed in an appropriate location and located as close as possible to the highest load concentration points.

Main low voltage switchboard or collective line switchboard with isolator not exceeding 1250 A may consist of:

- Switchboards in cabinets fixed to walls, in embedded or semi-embedded mounting.
- Switchboards in boxes fixed to the walls, in surface mounting when installed in niche, vertical duct or compartment with door.

Main low voltage switchboard with isolators exceeding 1250 A shall be made of panels in modular cabinets with panels installed on the floor, properly compartmentalized with normal power supplied from CEM network and emergency power supplied from emergency generator.

Access to the area inside the switchboards for connection, maintenance and adjustment of the appliances shall be ensured by means of doors or covers, equipped with a device for sealing by CEM.

Main low voltage switchboards shall be designed and located so that the width of service and maneuvering pass way is not less than those mentioned in Figure 1.1, Figure 1.2 and Figure 1.3.

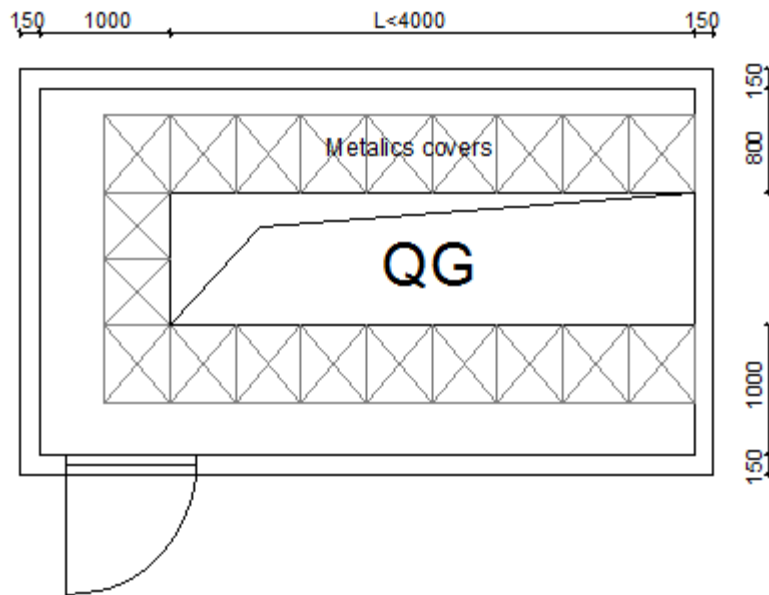

Figure 1.1 – Minimum dimensions for main low voltage switchboard installation for collective installations with back connection, with length  $L < 4m$ .

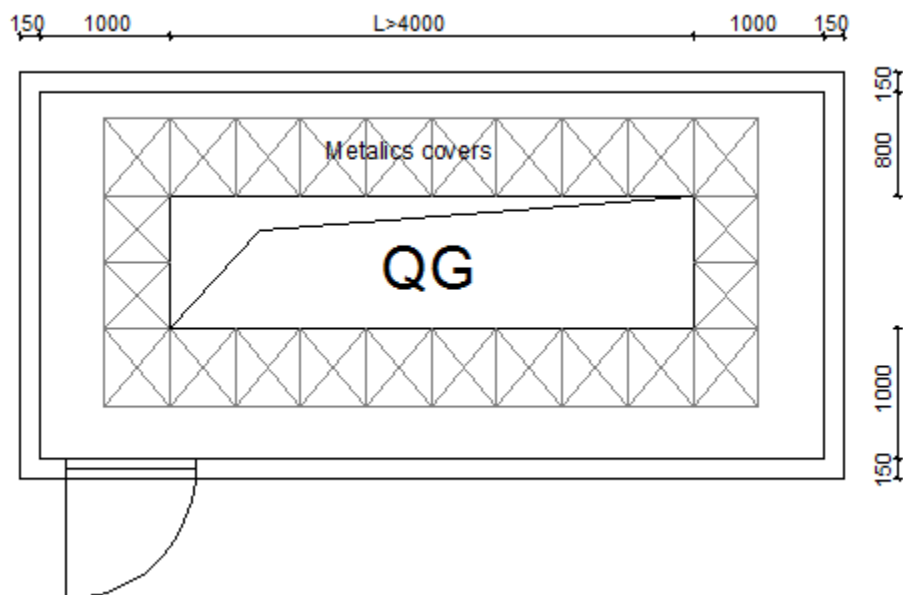

Figure 1.2 – Minimum dimensions for main low voltage switchboard installation for collective installations with back connection, with length  $L > 4m$ .

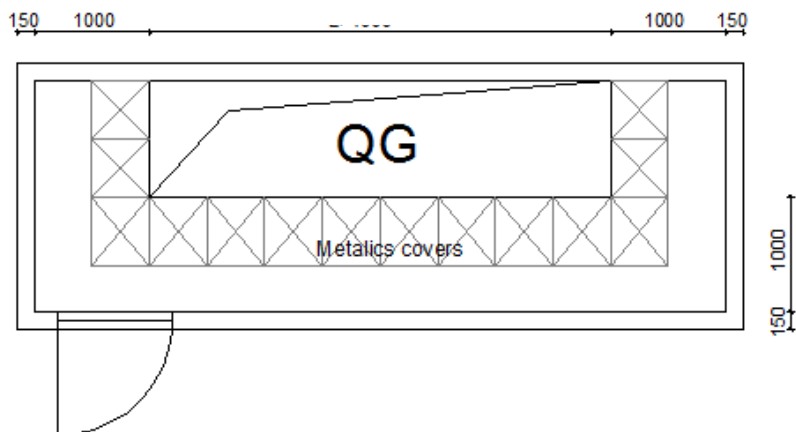

Figure 1.3 – Minimum dimensions for main low voltage switchboard installation for collective installations with front connection.

Main low voltage collective switchboards that supply both residential and commercial premises must be designed with a 50% spare capacity for commercial premises in terms of number of outgoings and power demand.

Typical arrangements for building’s collective installation and their connection to CEM network are presented in Annexes 3, 4 and 5.

For the purpose of distribution network simplicity and optimization and its maintenance, the electrical design of new buildings must be as much as possible in line with the concept of one supply point per building (as defined in 4.2). In this regard, the use of potheads to supply the commercial premises of new buildings should be restricted. Annex 11 presents supply methods to commercial premises.

#### 4.5 Service-entrance line from collective installation

Service-entrance lines with requested power up to 55.2 kVA may be supplied from collective line by means of collective line distribution boxes installed on the same floor as the supply point of the electrical installation, or directly from main collective switchboard or main low voltage switchboard.

Service-entrance lines with required power over 55.2 kVA may be supplied directly from the main collective switchboard or main low voltage switchboard.

Electrical wiring and related equipment for service-entrance line shall be installed in building's common areas.

Electrical wiring related to the supply of electrical installations, from their supply point and along their route, shall be installed in areas with easy access for operation and maintenance, under customer responsibility.

Service-entrance lines should be in accordance with the following cable sizing:

Subscribed Demand	Cable size
3.4 kVA (1x16 A)	3x6 mm <sup>2</sup>
6.9 kVA (1x32 A)	3x10 mm <sup>2</sup>
11.5 kVA (1x50 A)	3x16 mm <sup>2</sup>
13.8 kVA (3x20 A)	5x16 mm <sup>2</sup>
20.7 kVA (3x32 A)	5x16 mm <sup>2</sup>
34.5 kVA (3x50 A)	5x16 mm <sup>2</sup>
41.4 kVA (3x60 A)	5x25 mm <sup>2</sup>
55.2 kVA (3x80 A)	5x25 mm <sup>2</sup>

If the requested subscribed demand is higher than 55.2 kVA, the metering system should be indirectly connected and a current transformer chamber and box are required, as defined in NCEM C62-315 and NCEM C62-316.

## 4.6 Energy meter

For electrical installations with requested power up to 55.2 kVA, metering is ensured by an active energy meter. The control of requested apparent power is made by a circuit breaker supplied and installed by CEM.

For electrical installations with requested power over 55.2 kVA, metering is ensured by an active and reactive energy meter supplied by current transformers. The cable between the current transformers and the meter shall be of type 2 VD32 + VV10x6 mm<sup>2</sup> and shall not exceed 10 m distance. The control of requested apparent required power is made by a circuit breaker supplied and installed by the owner.

Metering equipment of any electrical installation shall be installed in a suitable location and easily accessible, near the supply point of the electrical installation or the supply point of the service-entrance line.

Metering equipment of any electrical installation with connections from CEM network should be installed in an individual cabinet and one of the following solutions can be adopted:

- Isolator switch, meter, meter and current transformer, in the enclosure of the electrical installation, should be located as far as possible, next to the normal access and the respective collective installations and / or service-entrance lines.
- Meter installed on the building's façade or property sealing wall next to the respective collective installation and/or service-entrance lines. The isolator of the electrical installation is, as a rule, in the niche of the service switchboard.
- Meter installed on the façade of the building or property sealed wall, next to the respective collective installation and service-entrance lines. Isolators of service-entrance lines and current transformers are placed in the enclosure of the electrical installation adjacent to the meters.

It is recommended that the meter is installed in an easy access location and does not require the intervention of third parties for CEM access.

Metering equipment with connections from collective installation, for required power up to 55.2 kVA should normally be installed on individual boards, and one of the following solutions may be adopted:

- In spaces dedicated to common areas of a building, adjacent to the meter boards corresponding to the electrical installations on each floor or group of service-entrance lines, supplying from the same collective line.
- In spaces dedicated to the common areas of a building, adjacent to the normal access of the building, provided that all meters of that building are concentrated.

Metering equipment with connections from collective line, for required power over 55.2 kVA, should be installed inside an individual cabinet, in spaces dedicated to the common areas of the building, adjacent to the corresponding the electrical installations on each floor or group of service-entrance lines.

Spaces for the concentration of individual meter boards or cabinets shall be understood as follows:

- Niches equipped with door, for the installation of energy meter.
- Rooms, technical corridors or vertical ducts equipped with door, intended for the installation of collective line, collective line distribution boxes and energy meters.

Annex 10 defines requirements for meter panels and meter rooms.

## **5 Dimensioning of electrical wiring**

In dimensioning of electrical wiring of collective installations and service-entrance lines, the following shall be taken into account:

- Type of electrical wiring
- Minimum cross-sectional area of electrical wiring
- Minimum power demand of the electrical installations
- Maximum voltage drop of the circuit
- Overcurrent in electrical wiring

To consider avoiding overload in neutral conductor, the minimum cross-section to be used can be equal to the cross-section of phase conductors.



## 5.1 Types of electrical wire

Collective lines consist of electrical wiring (see Annex 6) for overhanging or embedded mounting, consisting of the following types:

- Insulated conductors with nominal voltage 450/750 V protected by tubes.
- Rigid cables with nominal voltage 0.6/1 kV protected by tubes.
- Rigid cables with 2 sheaths or 1 reinforced sheath of nominal voltage 0.6/1 kV.
- Insulated conductors with nominal voltage 450/750 V protected by tubes and installed in ducts.
- Rigid cables with nominal voltage 0.6/1 kV, installed in ducts.
- Prefabricated conduits.

### 5.1.1 Insulated conductors and cables

Electrical conductors and cables shall comply with standards of IEC 60227, IEC 60228 for insulation voltage of 450/750 V and IEC 60502 for insulation voltage of 0.6/1 kV, and color codes of conductors in accordance with standard of IEC 60446.

Poles	Single phase system	Three-phase system
L1	Brown	Brown
L2		Black
L3		Grey
Neutral	Blue	Blue
Protection earth	Green-and-yellow	Green-and-yellow

Insulated cables and cables shall be designated according to the international system of CENELEC HD 361 (Annex 9).

### **5.1.2 Tubes**

Tubes shall be made of non-flame propagating material, resistant to humidity corrosion and be suitable at an ambient temperature from -5 °C to +40 °C.

Tubes of the same conduct shall be continuous without interposition of iron-magnetized materials. In collective line, the tubes shall be made in a diameter allowing easy fitting and detachment of insulated conductors or cables.

There shall be no protrusions, obstacles or cracks on the inner wall of the casing where the ascending line is installed.

For collective line consisting of insulated conductors of nominal voltage 450/750 V and VD tube, they shall not have nominal diameters less than those indicated in Table 1.4.

Table 1.4 – Nominal diameter of VD tubes, depending on the cross-sections and the number of conductors of collective line for the first installation.

Conductors cross- sections	Nominal diameter of tubes (mm)				
	Number of conductors				
	1	2	3	4	5
10	32	32	32	40	40
16	32	32	40	40	50
25	32	40	50	50	63
35	32	50	63	63	63
50	40	50	63	75	75
70	40	63	75	75	90
95	50	63	90	90	90
120	50	75	90	110	110
150	63	90	110	110	110
185	63	90	110	110	-
240	75	110	-	-	-
300	75	110	-	-	-
400	90	-	-	-	-
500	110	-	-	-	-

If cables or other insulated conductors and different tubes are used for collective line, the diameter of tubes with straight cross-sections should be determined such that the sum of the cross-sections corresponding to the maximum average outer diameter of the insulated cables or conductors does not exceed 20% of the inner cross-section of the tube.

When there is an increase of power demand and a need to increase the nominal cross-section of the conductors of collective line, the occupancy rate is allowed to be 40% of the straight cross-section of the tube interior. In the situation of a second installation (increase of power demand), for collective line consisting of insulated conductors of nominal voltage 450/750 V, and VD tubes, they shall not have nominal diameters less than those indicated in Table 1.5.

Table 1.5 – Nominal diameter of VD tubes, depending on the cross-section and the number of conductors of collective line for second installation.

Nominal section of conductors (mm)	Nominal diameter of tubes (mm)				
	Number of conductors				
	1	2	3	4	5
10	16	20	25	32	32
16	16	25	32	32	32
25	20	32	32	40	40
35	25	32	40	40	50
50	25	40	50	50	50
70	32	40	50	63	63
95	32	50	63	63	75
120	40	50	63	75	75
150	40	63	75	75	90
185	50	63	75	90	90
240	50	75	90	90	110
300	63	75	110	110	110
400	63	90	110	110	-
500	75	110	-	-	-

### 5.1.3 Ducts

Ducts, or non-electrical wiring, e.g. gas, water, heating, air-conditioning and ventilation, shall be separated from the collective installation conducts and service-entrance lines, and shall not under any circumstances be installed or cross the ducts in location where there is a risk of explosion.

Exception to the rule, the horizontal crossings of duct of collective installations and service-entrance lines are allowed, provided that the non-electric lines are protected by means of rigid and watertight conduits and at least the outer surface is in insulation material. Non-electric installations shall be at least 30 mm from the electrical conduits.

Where necessary, thermal insulation of the collective installations and service-entrance lines, e.g. with respect to the installations to the heating installations, shall be ensured that the ambient temperature of the duct does not exceed 30 °C.

In ducts of collective installation and service-entrance lines, only the passage of other installation intended for the building's common services shall be permitted and shall have the following characteristics:

- Continuous and watertight walls built of masonry or concrete shall not have any protrusions or obstacles along the wall where the collective lines are installed.
- Construction materials shall be non-combustible and have a fire resistance rating not lower than the setting of the location of a building where they are installed.
- Free passageways on floor level should be filled by a rigid whole plate of fireproof material that is non-combustible and can withstand a person's weight and in accordance with Regulamento de Segurança contra Incêndios. There shall be a raised step of 50 to 100 mm on the opening side, separating the exterior and the interior of the duct.
- To serve all building floors, where they are installed and whenever possible, have rectilinear channel and have no directional changes.
- Accessibility from steps, corridors or other common areas of a building and location without direct communication with the exterior of the building.
- The number and dimensions of the openings, which are possible to access or visit to the duct, shall be determined according to the installed equipment, maintenance, and operation of the equipment.

## 5.2 Dimensioning of collective lines

The nominal cross-section of collective line shall be calculated according to the required power of electrical installations in Table 1.1 and Table 1.2, the application of the coincident factors  $K_s$  of Table 1.3, the maximum permissible voltage drop, the maximum allowable currents in electrical wiring and the selectivity of the protections.

The electrical wiring of collective line or branch line should be in three-phase (3P + N + PE) and with a cross-section not less than 10 mm<sup>2</sup>. As a rule, the conductors shall have the same number and nominal cross-section.

When designing the cross-section of electrical wiring and their overcurrent protection devices, it shall take into account the manner of installing the common collective line or service-entrance line (Annex 6), the permissible currents in electrical wiring (Annex 7), and simultaneously meet the two coordinated conditions between the conductors and the protections.

The following tables show the dimensioning of common collective line commonly used for protection fuse rating  $32(A) \leq I_n \leq 200(A)$  for copper conductors insulated in circular conduits (tubes) in surface mounting in Table 1.6, and for single-core or multicore copper cables fixed by braces on the walls or ceilings in Table 1.7.

Table 1.6 – PVC insulated copper conductors in surface mounting circular conduit (tubes).

(1) Conductors cross-sectional area (mm <sup>2</sup> )			Diameter of VD tube	(3) Rated current of fuse (A)	(1) Admissible current in the electrical wiring (A)	(4) Apparent power (kVA)	
Phase L1/L2/L3	Neutral N	Protection PE				Nominal	Max.
16	16	16	40	32 (T0)	62	21	29
16	16	16	50	50 (T0)	62	33	41
25	16	16	63	63 (T0)	84	41	55
35	16	16	63	80 (T0)	106	53	70
50	25	25	75	100 (T1)	123	66	81
70	35	35	90	125 (T1)	163	82	107
95	50	50	90	160 (T1)	198	105	130
120	70	70	110	200 (T1)	233	132	153

(1) Ambient temperature 30 °C  
 (2) Conductors identified by IEC 60446 (L1=brown; L2=black; L3=gray; N=blue; PE=green-and-yellow.  
 (3) High-shear fuses gG, size indicated in parentheses.  
 (4) Nominal value according to the protective rated current and maximum value according to the permissible current of the electrical wiring.

Table 1.7 – PVC insulated single-core or multicore copper cables fixed by clamps on the walls and ceilings.

(2) Conductors cross-sectional area (mm <sup>2</sup> )			Diameter of VD tube	(3) Rated current of fuse (A)	(1) Admissible current in the electrical wiring (A)	(4) Apparent power (kVA)	
Phase L1/L2/L3	Neutral N	Protection PE				Nominal	Max.
16	16	16	-	32 (T0)	79	21	37
16	16	16	-	50 (T0)	79	33	52
25	16	16	-	63 (T0)	97	41	64
35	16	16	-	80 (T0)	114	53	75
50	25	25	-	100 (T1)	132	66	87
70	35	35	-	125 (T1)	173	82	113
95	50	50	-	160 (T1)	207	105	136
120	70	70	-	200 (T1)	238	132	157

(1) Ambient temperature 30 °C  
(2) Conductors identified by IEC 60446 (L1=brown; L2=black; L3=gray; N=blue; PE=green-and-yellow.  
(3) High-shear fuses gG, size indicated in parentheses.  
(4) Nominal value according to the protective rated current and maximum value according to the permissible current of the electrical wiring.

When supplying non-linear loads, which generate currents with high harmonic content, and to avoid overloading the neutral conductor, it should be considered that the current-carrying capacity of the neutral wire is not less than that of the phase conductor.



### **5.3 Independent collective lines**

The electrical installations of common services or others that may disturb the electrical installations of a building should be supplied directly from the building main collective switchboard or main low voltage switchboard.

If the electrical installations of common building services serve only lighting and low-power sockets, their power may be supplied from the collective line distribution boxes of the floor where the respective electrical switchboard is installed.

### **5.4 Protective conductor**



Collective line shall be provided with a protective conductor for protection, established in accordance with current standards and regulations in force in Macau SAR, and having a nominal cross-section not less than 16 mm<sup>2</sup>.

It is also called protective conductor a conductor used to ground some equipment for functional or other purposes but which, because they do not perform safety functions, should not be identified by the double yellow-green coloration.

Protective conductors that are used to ground some equipment for functional purposes or to avoid disturbances (noiseless earth), because they do not perform a safety function, will not be identified as yellow-green, since they could lead to dangerous situations or disturbances for devices that have been connected to these drivers.

Protective conductors intended for a safety function and others which do not ensure a safety function shall be marked in accordance with the following table:

Table 1.8 – Marking of protective conductors

Protective conductor	Identification	Marking of terminals
A – Ensuring a safety function		
1. Connecting conductive part to earth electrode as the protection method against indirect contact by automatic power cut-off.	Green-and-yellow	E
2. Connecting between conductive part of equipment supplied by the secondary side of isolation transformers.	Green-and-yellow	E
3. Ensuring an equipotential bonding of: <ul style="list-style-type: none"> <li>• Main protective conductor</li> <li>• Main equipotential conductor</li> <li>• Auxiliary equipotential conductor</li> <li>• Local protective conductor, not connected to earth</li> </ul>	Green-and-yellow	E
B –Not ensuring a safety function and earthing to conductive part of an equipment		
1. For functional reasons	(1) (2)	TE
2. For disturbances reasons	(1) (3)	TE
<p>(1) The double yellow-green coloration shall not be used. No color is defined but the respective terminals shall be marked with the symbols indicated in the table.</p> <p>(2) Alternatively the terminals can include the  symbol (equipotential bonding).</p> <p>(3) Alternatively the terminals can include the  symbol (earth without noise).</p>		

## 5.5 Continuity of collective lines

In the sections of collective lines with the same nominal cross-section, the conductors should not be cut along their path, only cutting of insulation in collective line distribution boxes is allowed for the execution of branches.

When the rated cross-sectional area of the conductor of the collective lines decreases, should be considered the installation of overcurrent protection devices in the collective line boxes where they are originated.

The collective lines constituted by prefabricated electrical wiring (busbars) can have rushes provided that they guarantee a perfect electrical continuity and avoid accidental interruption. The bypass conductors should be made with independent grips of the joints.

## 5.6 Voltage drop

Voltage drop between the supply point of the installation and any point of use, expressed as a function of the rated voltage of the installation, shall not be higher than the values expressed in the following table:

Table 1.9 – Maximum permissible voltage drop

Application	Illumination	Other application
A. Installations supplied directly from a low voltage distribution network.	3%	5%
B. Installations supplied from a MV / LV transformer substation (1)	6%	8%
(1) Wherever possible, the voltage drops in the final circuits shall not exceed the values indicated in situation A. Voltage drops shall be determined from the power absorbed by the apparatus with respective coincident factors or, in the absence of these information, shall be determined from the service currents of each circuit.		

## 5.7 Protection against overcurrent

Active conductors shall be protected against overloads and short circuits by one or more automatic cut-off devices and the overload protection shall be coordinated with the short-circuit protection.

The protection devices must be circuit breakers, fused circuit breakers, with gG or aM type fuse. These protective devices shall be capable of interrupting any overcurrent not less than the prospective short-circuit current at the point where they are installed.

The devices that only provide short-circuit protection (when the overload protection is done by other devices or is waived) should be able to interrupt any short-circuit current not exceeding the prospective short-circuit current. These protection devices may be circuit breaker which is capable of breaking maximum short circuit current or fuse type gG or aM.

In case of collective line distribution boxes, the overcurrent protection of the entrance-service line shall consist of aM fuses with high cutting power fuse cartridges applied to the phase conductors of rated current as indicated in the following table.

Table 1.10 – Rated current of overcurrent protection device in collective line distribution box

Circuit breaker provided by CEM	In(A)			
	16	20	32	50
aM fuse cartridges	32	32	32	50

### 5.8 Protection against overload

Protective devices must interrupt the overloads of the circuit conductors before they can cause any damage to the insulation, the connections, the terminations or the elements close to the cables.

For the coordination between conductors and protective devices, these two conditions must be satisfied:

- a)  $I_B \leq I_n \leq I_Z$
- b)  $I_2 = 1,45 I_Z$

where:

- $I_B$  is the circuit operating current in amperes;
- $I_Z$  is the permissible current in electric line (Annex 6) in amperes;
- $I_n$  is the rated current of the protective device in amperes;
- $I_2$  is the conventional operating current, in amperes;

The conventional operating current of the protection device,  $I_2$ , is equal to:

- operating current, within the conventional time, for the circuit breakers.
- fusing current, within the conventional time, for the fuses type gG.

The schematics below shows the concept and the conditions described.

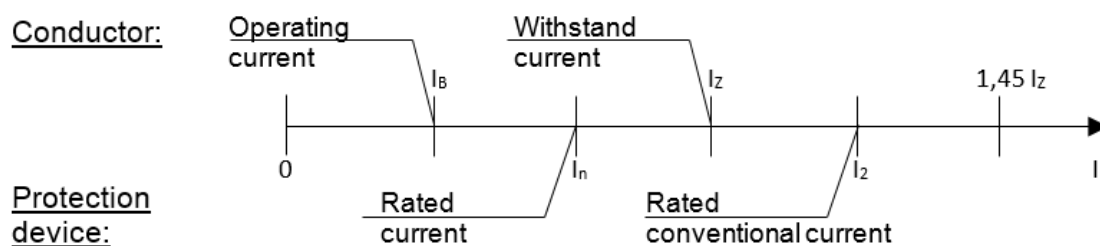

For conductors in parallel, the value of  $I_Z$  is considered as the sum of permissible currents in different conductors, provided that the current carried by each conductor is roughly the same.

## 5.9 Protection against short-circuit

Protection devices shall be provided which interrupt short-circuit currents before they can become dangerous due to the thermal and mechanical effects on the conductors and connections.

The prospective short-circuit currents shall be determined by the calculation at all necessary installation points.

The cutting power shall not be less than the prospective short-circuit current at the point where the device is installed, unless there is a device with an appropriate cutting power on upstream side. In this case, the characteristics of the two devices should be coordinated in a way such that the energy which the upstream device allows to pass is not higher than the energies which can be supported by the downstream device and the protective electric lines.

The current cut-off time resulting from short-circuit occurring at any point in the circuit shall not exceed the time necessary to raise the temperature of the conductors up to their permissible limit.

For short circuits with duration not more than 5 seconds, the time required for a short-circuit current to raise the temperature of the conductors from the maximum permissible temperature in a normal service until the limit value may be calculated by the following formula:

$$\sqrt{t} = k \frac{S}{I_{cc}}$$

where:

$t$  is the time in s;

$S$  is the cross-sectional area of conductors in mm<sup>2</sup>;

$I_{cc}$  is the weak short-circuit current verified at the farthest point of circuit in A;

$k$  is a constant factor assumed as the following value:

- 115; for copper conductor insulated in polyvinyl chloride;
- 134; for copper conductor insulated in rubber for general use or butyl rubber;
- 143; for copper conductor insulated in polyethylene or ethylene propylene;

- 76; for aluminum conductor insulated in polyvinyl chloride;
- 89; for aluminum conductor insulated in rubber for general use or butyl rubber;
- 94; for aluminum conductor insulated in polyethylene or ethylene propylene;
- 115; for tin soldered joints in copper conductors (corresponding to a temperature of 160 °C.)

The cut-off time  $t_c$  of the short-circuit protection device should satisfy the condition of  $t_c < t$ .

## **6 Electrical symbols**

In practice, for the purpose of design and implementation of electrical installations, it is necessary to adopt a series of graphic signals which symbolically represent various appliances, machines or other parts of the circuits.

In order to standardize, it intends to use the graphic symbols of IEC 60617 as a way to standardize as much as possible, the electrical symbols used in plant drawings, and in electrical diagrams or diagrams that constitute the collective installations and service-entrance lines of buildings.

In addition to the graphical symbols of IEC 60617, Annex 2 presents some graphic symbols used by CEM in the drawings of power distribution network.



## **ANNEX 1**

### **APPLICABLE STANDARDIZATION (Legislation, Regulations and Standards)**

#### **1 - MACAU LEGISLATION**

Decree-Law No. 79/85/M, 3<sup>rd</sup> August – Regulamento Geral de Construção Urbana.

Law No. 1/2015 – Regime de Qualificações no Domínio da Construção Urbana e do Urbanismo.

Decree-Law No. 43/91/M, 15<sup>th</sup> July – Condições Gerais de Fornecimento e Venda de Energia Eléctrica em Baixa Tensão e Média Tensão.

Decree-Law No. 53/98/M, 16<sup>th</sup> November – Altera o Contrato Tipo para o Fornecimento de Energia Eléctrica em Baixa Tensão e Média Tensão.

3<sup>rd</sup> November 2010 – Contrato de Prorrogação da Concessão do Serviço Público de Fornecimento de Energia Eléctrica na Região Administrativa de Macau.

Administrative Regulation No. 11/2005 – Regulamento de Comparticipações para Ligações à Rede de Energia Eléctrica.

Administrative Regulation No. 26/2004 – Regulamento de Segurança de Subestações e Postos de Transformação e Seccionamento.

Administrative Regulation No. 35/2011 – Procedimentos para a Emissão de Licenças de Exploração de Instalações Eléctricas.

#### **2 - PORTUGUESE REGULATIONS AND STANDARDS**

Regulatory Decree No. 90/84, 26<sup>th</sup> December – Regulamento de Segurança de Redes de Distribuição de Energia Eléctrica em Baixa Tensão.









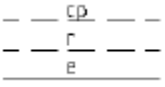
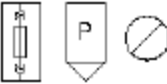

Decree-Law No. 226/2005, 28<sup>th</sup> December – Estabelece os procedimentos de aprovação das regras técnicas das instalações eléctricas de baixa tensão

Portaria No. 949-A/2006, 11<sup>th</sup> September – Aprova as Regras Técnicas das Instalações Eléctricas de Baixa Tensão

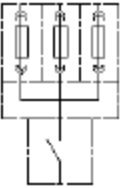
Portaria No. 252-A/2015, 19<sup>th</sup> August – Procede à alteração da Portaria n.º 949-A/2006

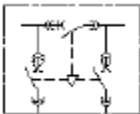
**ANNEX 2**

**ELECTRICAL SYMBOLS**

	<p>Power transformer (11/0.4 kVA)</p>
	<p>LV distribution network – main line (3P+N)                  LV distribution network – branch lines (3P+N)                  Service-entrance lines (1P+N+PE) or (3P+N+PE)</p>
	<p>CEM pothead</p>
	<p>Connection point to the network</p>
	<p>LV switchboard (QC – collective main switchboard, QG – main LV switchboard)</p>
	<p>Caixa ou compartimento</p>
	<p>Box or compartment</p>
	<p>Main switchboard equipped with withdrawable service 4-pole circuit breaker with mechanical locking device by padlock in open position</p>
	<p>Main switchboard equipped with withdrawable service 4-pole circuit breaker and inter-busbar with mechanical locking device by padlock in open position and by key between the circuit breaker and the inter-busbar</p>
	<p>Service circuit breaker</p>
	<p>Current transformer</p>
	<p>Metering equipment</p>
	<p>Origin of the electrical installation</p>

## ANNEX 3

### EXAMPLES OF SUPPLY OF BUILDING COLLECTIVE INSTALLATIONS BY INCOMING LINES OR BRANCHES FROM THE ELECTRICITY DISTRIBUTION NETWORK

#### **Application field**

Buildings with electrical installation operated by different entities, equipped with a collective installation for the supply of respective electrical installations.

#### **General Conditions of Use**

The power supply of low voltage electrical installations of buildings can be realized:

- From public distribution network in low voltage, for required power up to 70 kVA.
- From transformer substation, to be installed in the building, for required power higher than 70 kVA.
- In case of power requirements exceeding 70 kVA but not exceeding 350 kVA, CEM may allow power supply from the existing low voltage distribution network, where this is possible.
- In case the requested power exceeds 350 kVA, a transformer substation needs to be installed in the building and power supply from middle voltage network.

The piping and cable between the PH and CCL, or between PH and QC, must be designed for the maximum size: VD110 + V3x120+70 + T70 mm<sup>2</sup> to avoid future modification works.

## List of examples

### Annex 3.1 – Type APC 172.5. Supplying from public LV network (collective connection point), for required power up to 172.5 kVA.

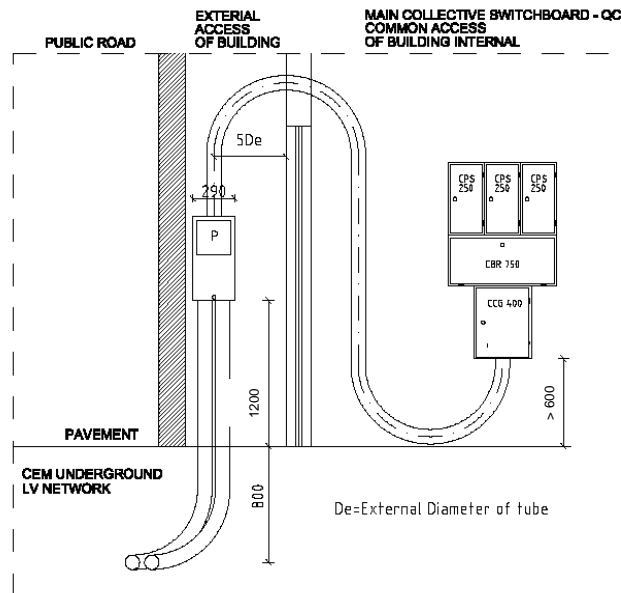

### Annex 3.2 – Type APC 340. Supplying from public LV network (collective connection point), for direct connection to main collective switchboard with required power over 172.5 kVA up to 340 kVA.

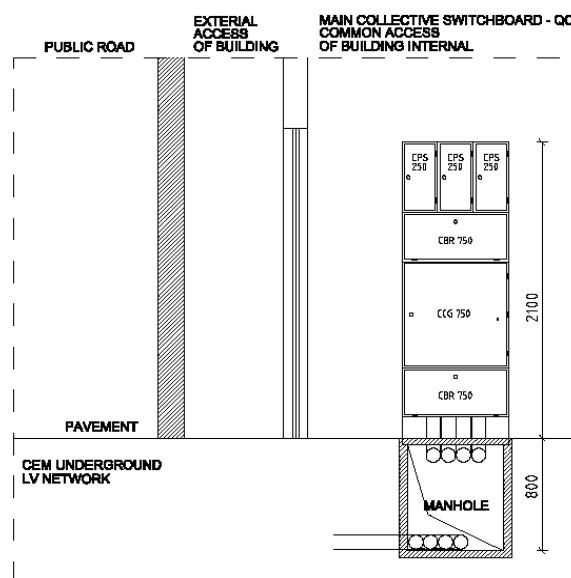

**Annex 3.3 – Type APC 690. Supplying from customer transformer substation in (collective connection point), for required power over 70 kVA up to 690 kVA.**

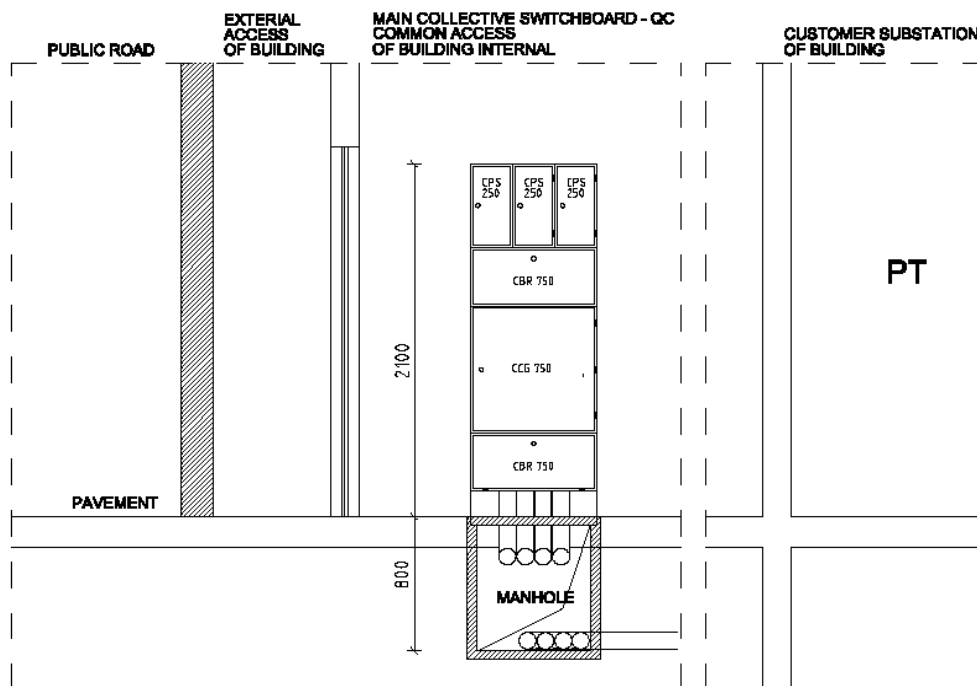

**Annex 3.4 – Type APC 1600. Supplying from customer transformer substation (collective connection point), for required power over 690 kVA up to 1600 kVA.**

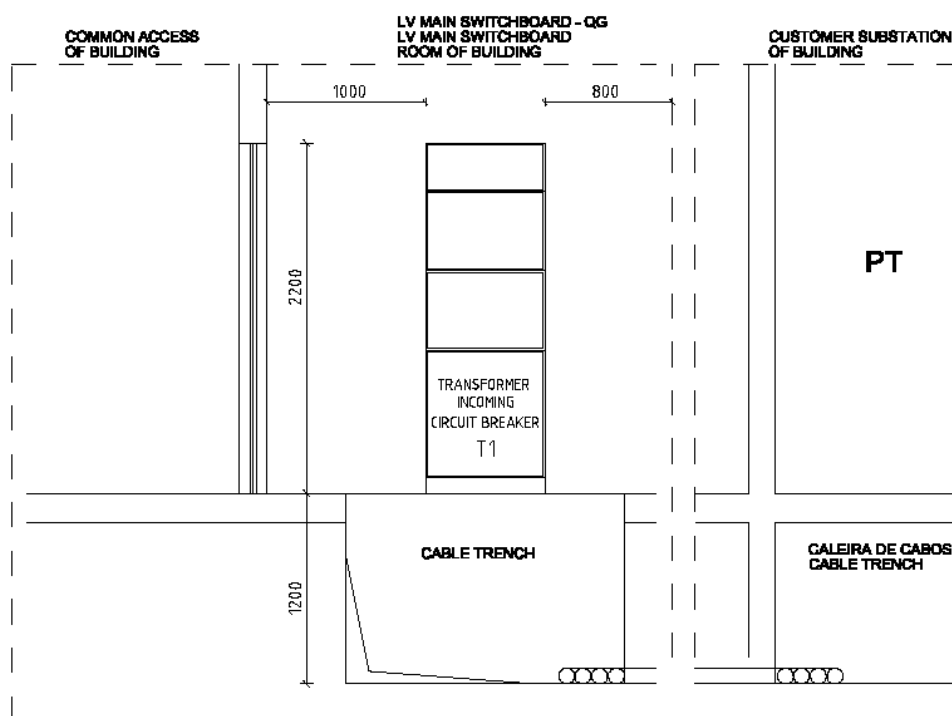

Annex 3.5 – Type APC 3200. Supplying from customer transformer substation (collective connection point), for required power over 1600 kVA up to 3200 kVA.

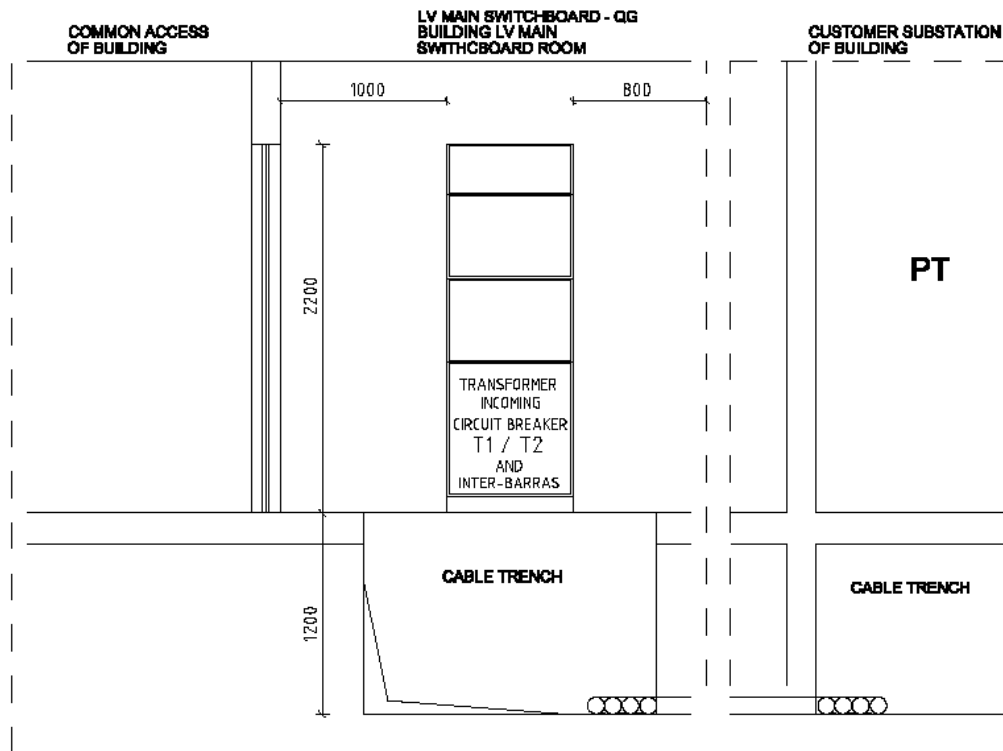

## **ANNEX 4**

### **EXAMPLES OF SUPPLY OF BUILDING COLLECTIVE INSTALLATIONS BY INCOMING LINES OR BRANCHES FROM THE ELECTRICITY DISTRIBUTION NETWORK**

#### **Application field**

Buildings with only one electrical installation (utilization) operated by a single entity.

Building's autonomous units with normal access from outside, and that it is not possible to power their electrical installations from the collective installation of the building, and duly justified and accepted by CEM.

#### **General Conditions of Use**

The power supply of low voltage building's electrical installations can be realized:

- From public distribution network in low voltage, for required power up to 70 kVA.
- From transformer substation, to be installed in the building, for required power higher than 70 kVA.
- In the case of power requirements exceeding 70 kVA but not exceeding 350 kVA, CEM may allow to supply power from the existing low voltage distribution network, if possible.
- In case the requested power exceeds 350 kVA, a transformer substation needs to be installed in the building and power supply from middle voltage network.

In the following examples, the location and environment where the meter is installed must also meet the requirements of Annex 10.2.

## List of examples

### 4.1 Supply from public distribution network in low voltage.

#### Annex 4.1 – Type API 55.2. Supply from public LV network (individual connection point), for required power up to 55.2 kVA\*

##### Characteristic of installation

Feeding through an individual connection point from underground LV network, by pothead installed on the building façade or property sealing wall, adjacent to the public access road.

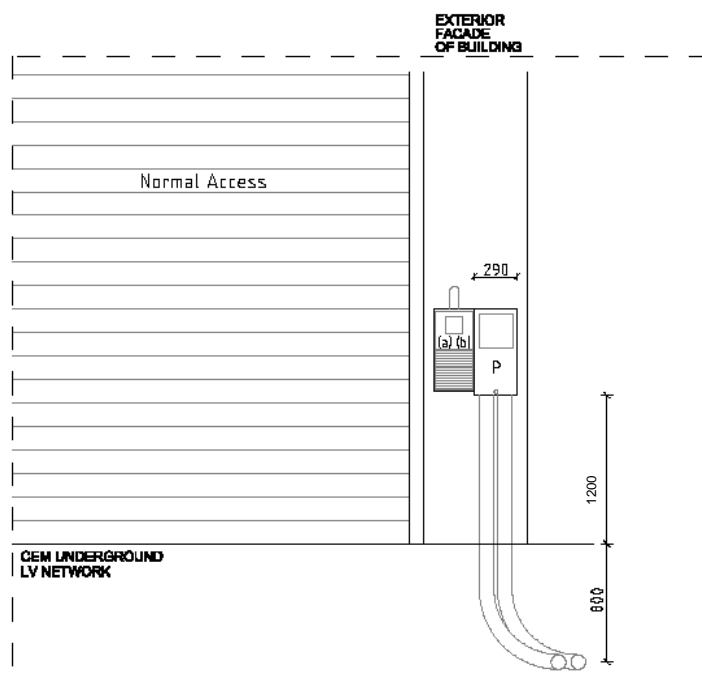



Annex 4.2 – Type APC 69. Supply from public LV network (collective connection point), for required power up to 55.2 kVA\* per meter.

Characteristics of installation

Supplying through an individual connection point from underground LV network, by pothead installed on the building façade or property sealing wall, adjacent to the public access road.

Solution recommended by CEM;

- (a) Meter cabinet installed next to pothead with a degree of protection of not less than IP43 / IK10.
- (b) Circuit breaker installed within the meter cabinet or the place where electricity is used.

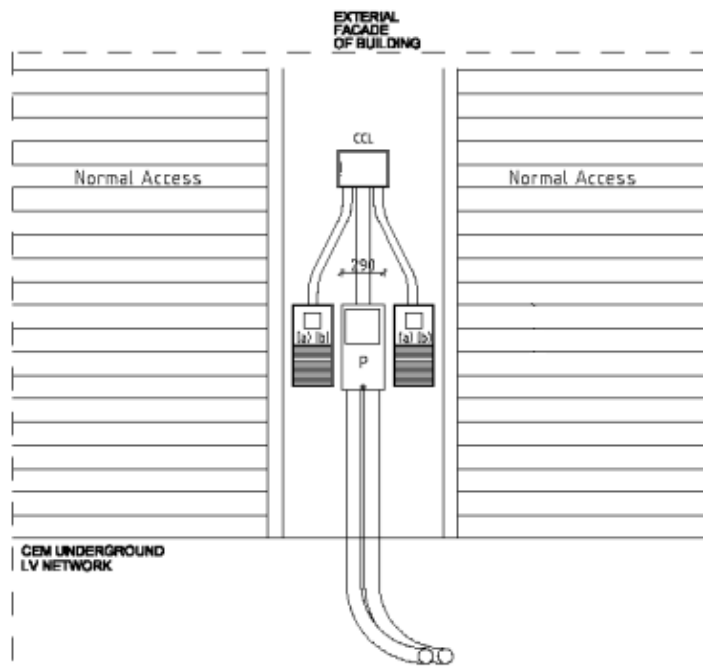

**Annex 4.3 –Type API 130. Supply from public LV network (individual connection point), for required power over 55.2 kVA\* up to 130 kVA.**

Solution recommended by CEM;

- (a) Meter cabinet installed next to pothead with a degree of protection of not less than IP43 / IK10.
- (b) The circuit breaker and the current transformer box should be installed near the door (within 2 meters) of the power supply location.

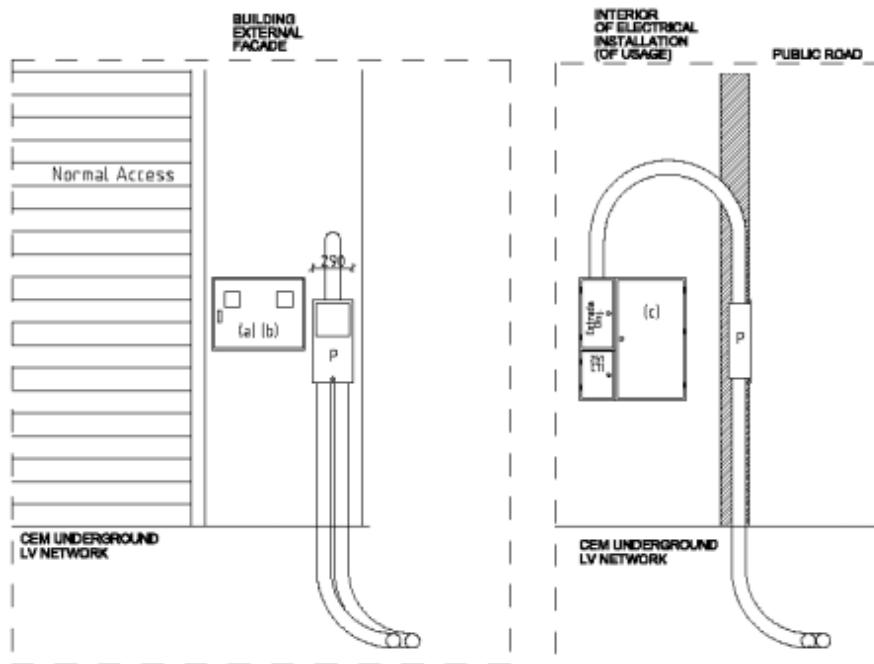

**Annex 4.4 – Type API 340. Supply from public LV network (individual connection point), for required power over 130kVA up to 350 kVA.**

**Characteristic of installation**

Supplying through an individual connection point from underground LV network, by direct connection to the service circuit breaker.

Solution recommended by CEM;

- (a) Energy meter cabinet installed facing the public road, with a degree of protection of not less than IP43 / IK10.
- (b) The circuit breaker and the current transformer box are installed together near the door (within 2 meters) of the power supply location or beside the public electrical device in the building where it is located.

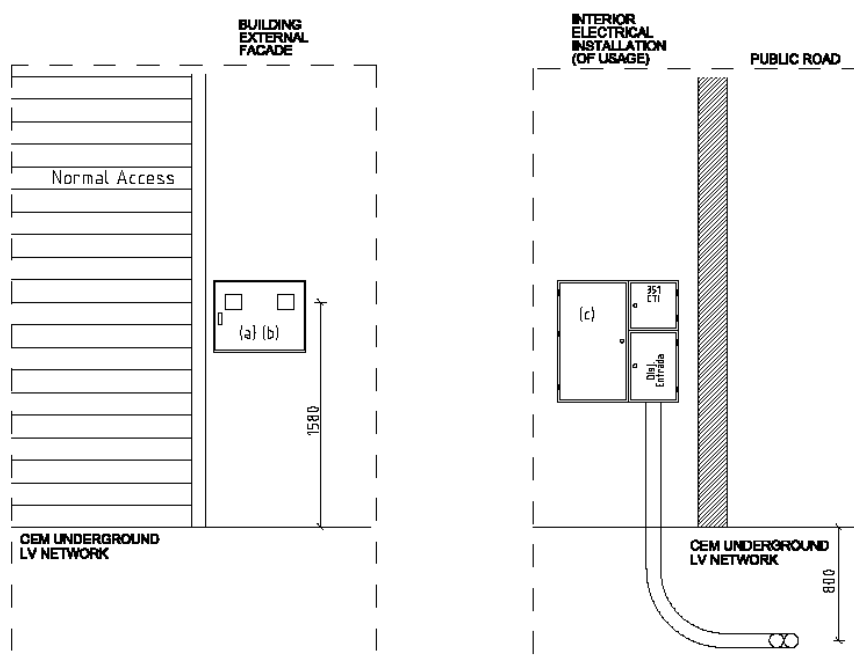

Annex 4.5 – Type API 690. Supply from customer transformer substation (individual connection point), for required power over 69 kVA up to 690 kVA.

Characteristic of installation

Feeding through an individual connection point from customer transformer substation integrated in the building by direct connection to the service circuit breaker.

Solution recommended by CEM

- (a) Energy meter cabinet installed facing the public road, with a degree of protection of not less than IP43 / IK10.
- (b) The circuit breaker and the current transformer box are installed together near the door (within 2 meters) of the power supply location or beside the public electrical device in the building where it is located.

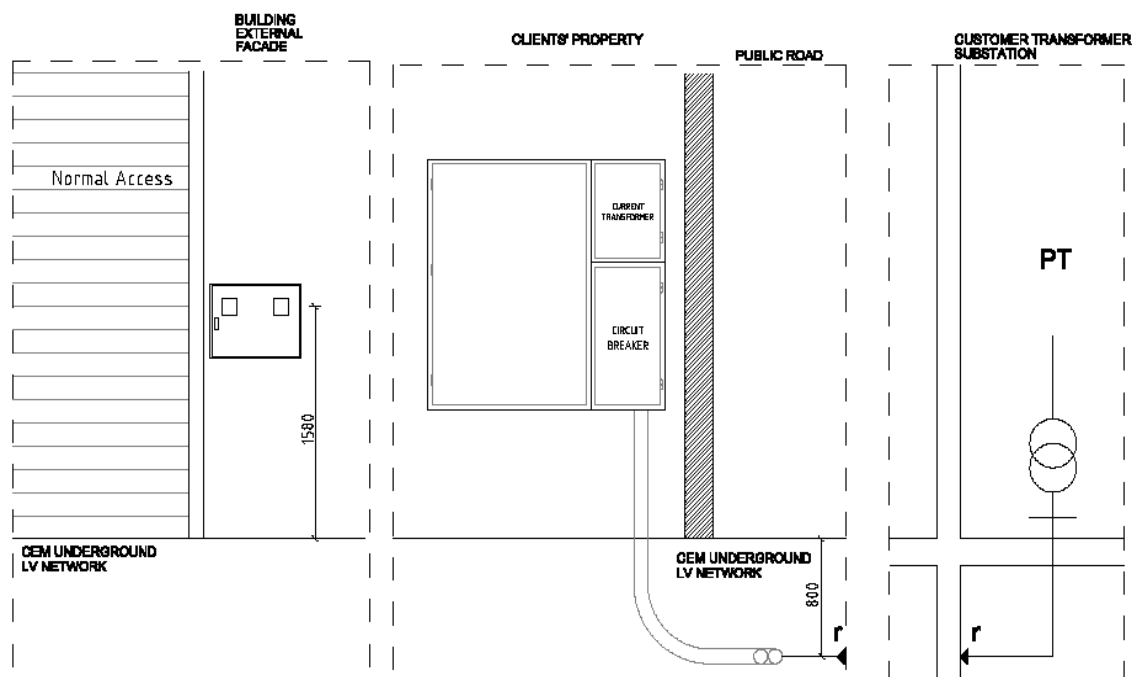

Annex 4.6 – Type API 1600. Supply from customer transformer substation (individual connection point), for required power over 690 kVA up to 1600 kVA.

Characteristic of installation

Feeding through an individual connection point from customer transformer substation integrated in the building by direct connection to the service circuit breaker.

Solution accepted by CEM:

- (a) Entrance circuit breaker, energy meter and current transformers installed within client’s QG room, nearby the normal access.

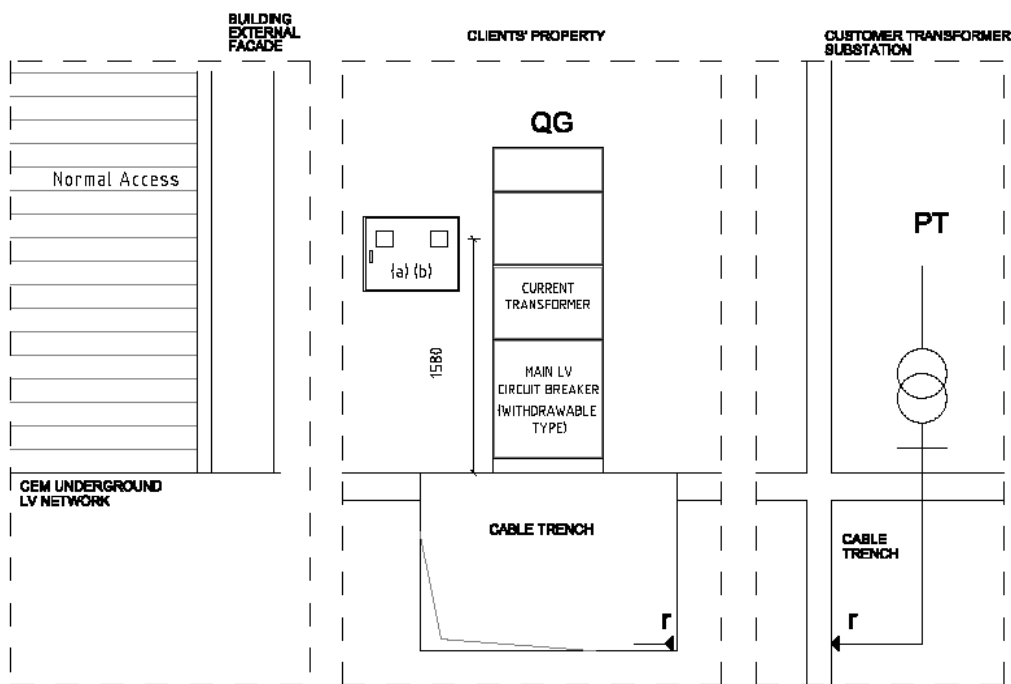

## **ANNEX 5**

### **TYPICAL ARRANGEMENTS OF COLLECTIVE INSTALLATIONS AND SERVICE-ENTRANCE LINES SUPPLIED FROM DISTRIBUTION NETWORK**

#### **Application field**

Buildings with electrical installations operated by different entities.

The power meters should preferably be concentrated in appropriate switchboard or meter rooms and not in each shop to avoid the installation of horizontal risers.

#### **List of examples**

Annex 5.1 – Example of building's collective installation supplied by low voltage distribution network.

Annex 5.2 – Example of building's collective installation supplied by one Customer substation integrated in the building.

Annex 5.3 – Example of building's collective installation supplied by one Customer substation integrated in the building.

Annex 5.4 – Example of building's collective installation supplied by one Customer substation integrated in the building.

Annex 5.5 – Example of building's collective installation supplied by two Customer substations integrated in the building.

### Annex 5.1

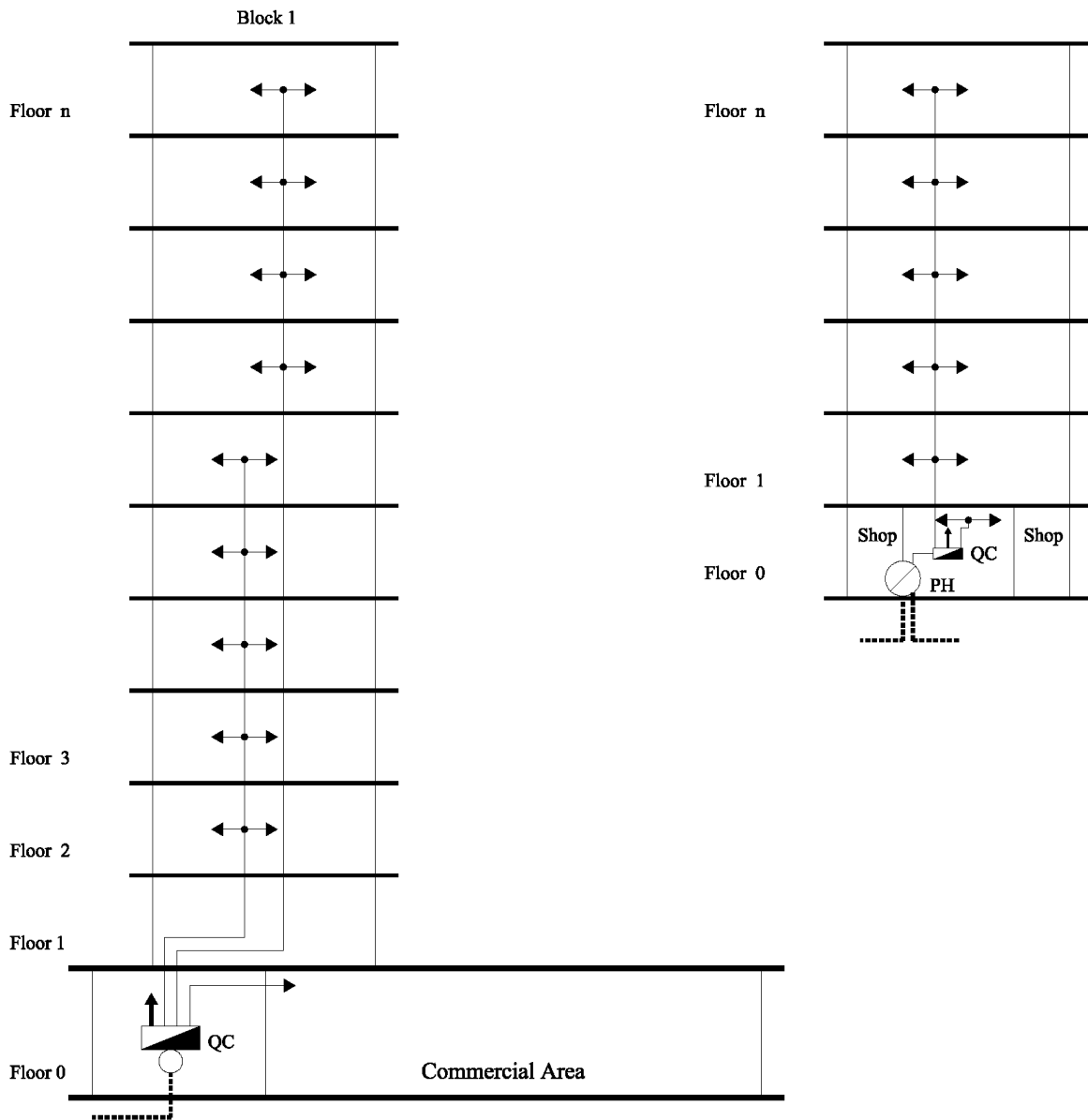

### Annex 5.2

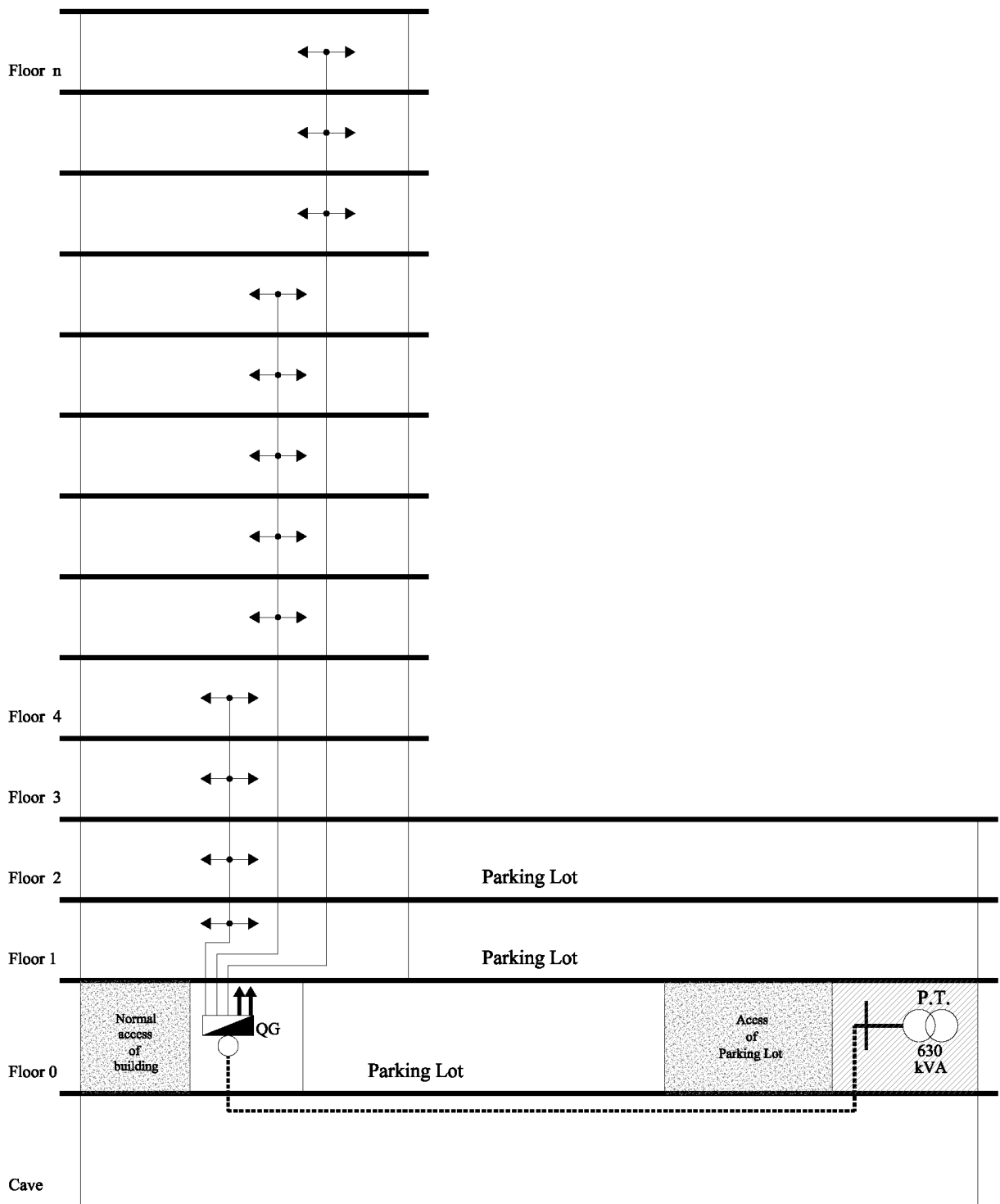



### Annex 5.3

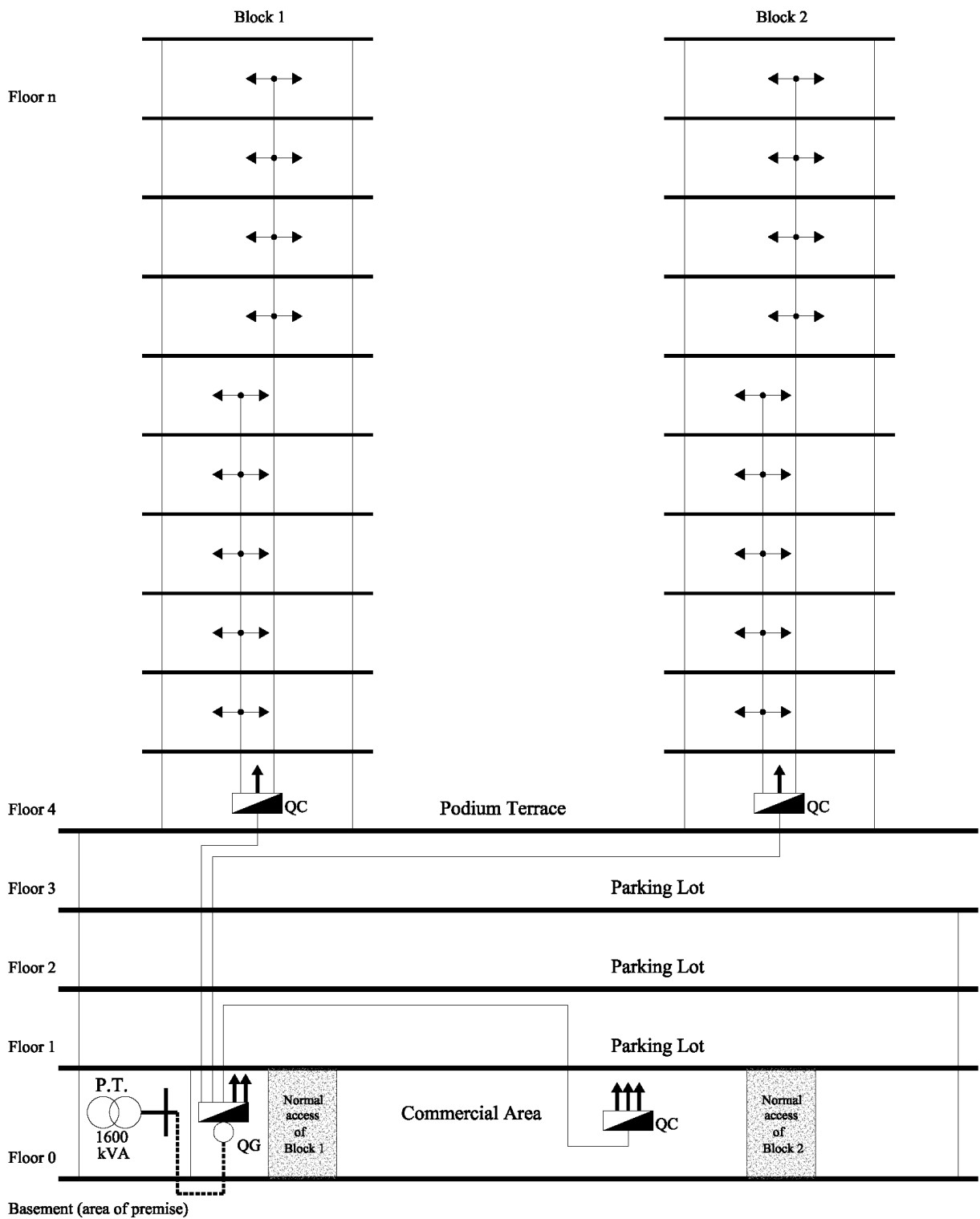

**Annex 5.4**

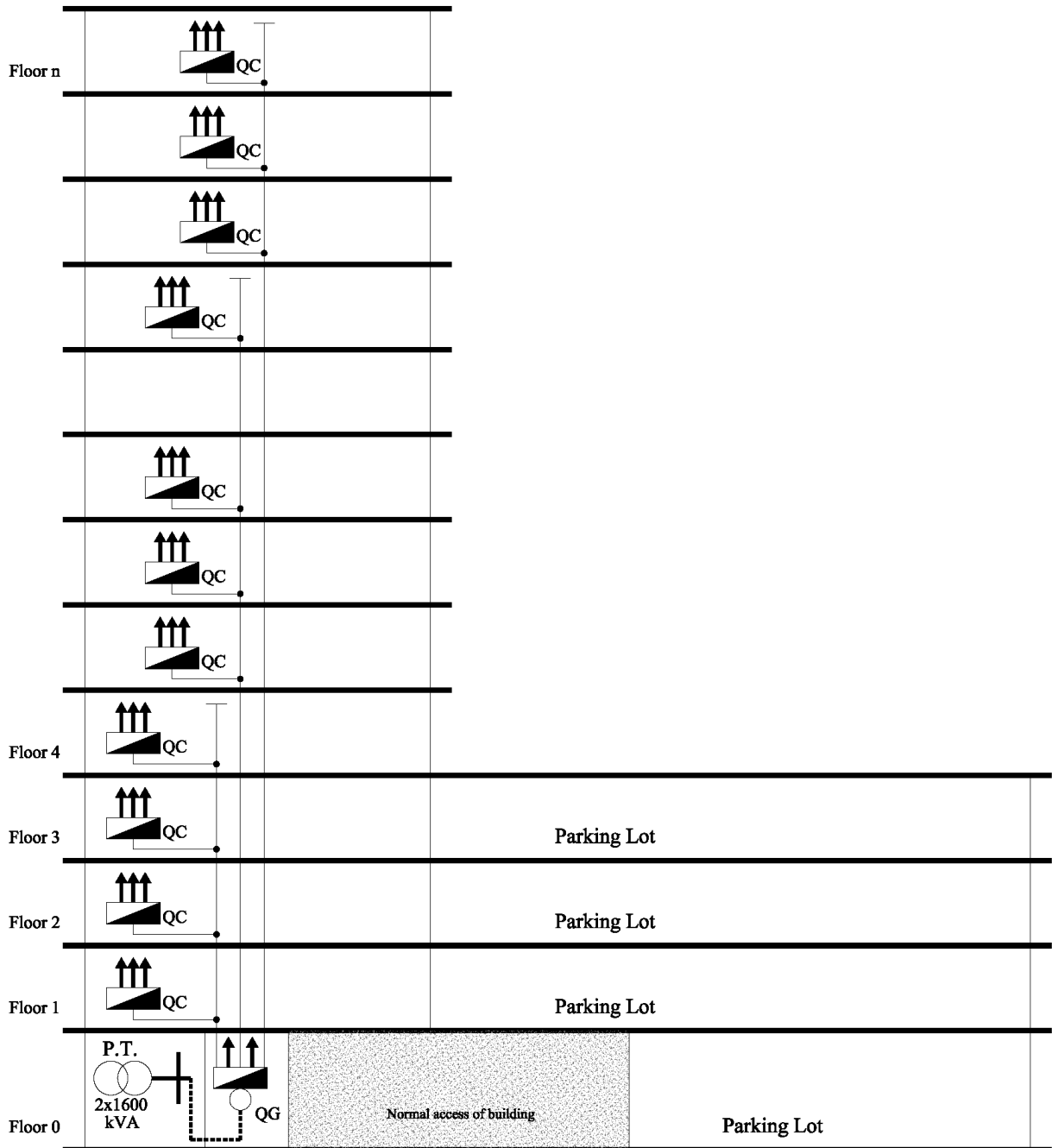

**Annex 5.5**

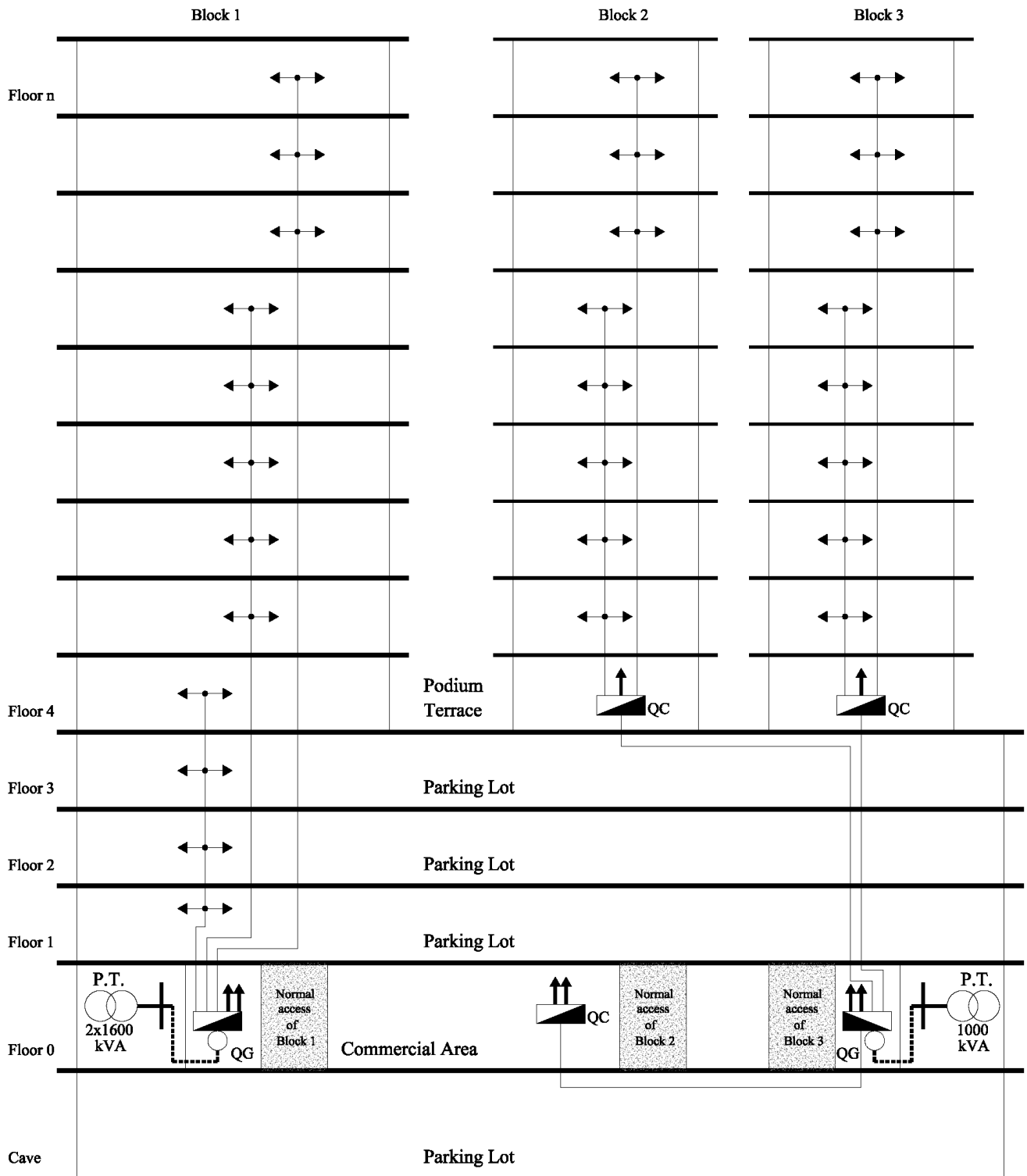

**ANNEX 6**

**EXAMPLES OF METHODS OF INSTALLATION OF CONDUITS**

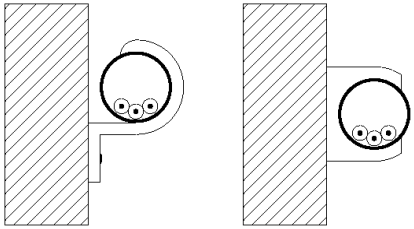
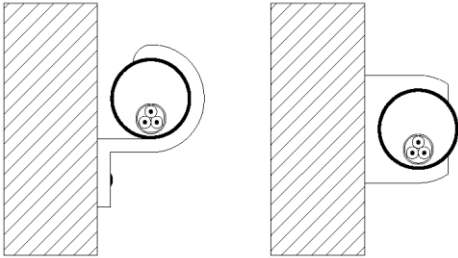
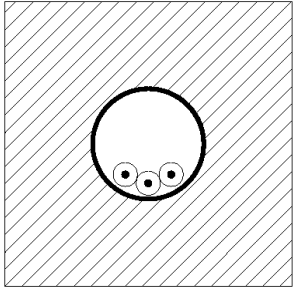
Method	Description	Reference method  (1)
	<p>Insulated conductors in circular conduits (tubes), surface mounting.</p>	<p>B</p>
	<p>Single-core or multicore cables in conduits (tubes), surface mounting.</p>	<p>B</p>
	<p>Insulated conductors in circular conduits (tubes) embedded in concrete.</p>	<p>B</p>

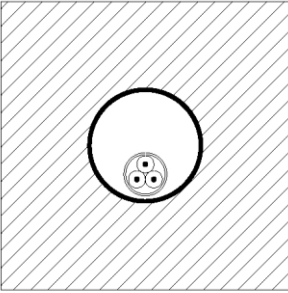
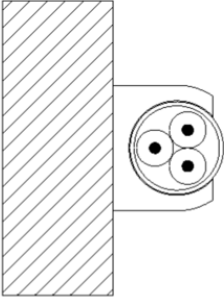
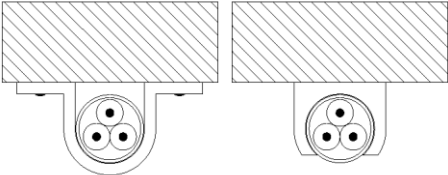
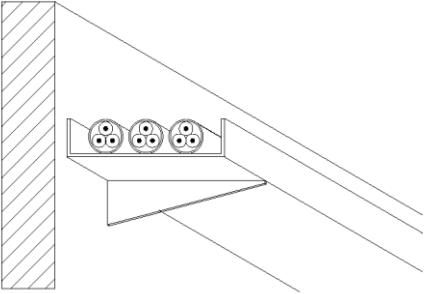
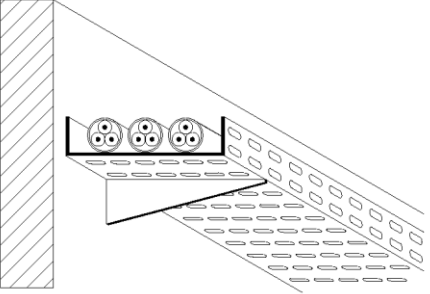
	<p>Single-core or multicore cables in conduits (tubes) embedded in concrete</p>	<p>B</p>
	<p>Single-core or multicore cables (sheathed or not) fixed to the walls</p>	<p>C</p>
	<p>Single-core or multicore cables (sheathed or not) fixed on the ceilings</p>	<p>C [3]</p>
	<p>Single-core or multicore cables (sheathed or not) on imperforated trunks</p>	<p>C [2] (3)</p>
	<p>Single or multi-core cables (with or without armature) on perforated tray</p>	<p>E or F (3)</p>

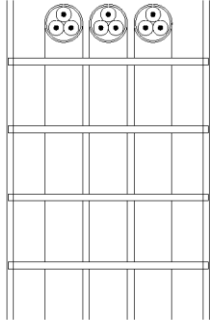
 <p>The diagram shows a ladder-like structure with four horizontal rungs and two vertical rails. At the top, three circular symbols representing cables are positioned across the top rung. Each symbol has two small circles inside, representing conductors.</p>	<p>Single or multi-core cables (with or without armature) on ladder</p>	<p>E or F or G</p> <p>(2)</p> <p>(3)</p>
<p>(1) See Annex 7.</p> <p>(2) For certain applications it may be more appropriate to use specific correction factors for the references E and F.</p> <p>(3) The values of permissible current can also be used for the vertical paths, when the ventilation conditions are limited to the temperature in the upper part that can become very high.</p>		

**ANNEX 7****ADMISSIBLE CURRENTS OF ELECTRICAL WIRINGS**

Annex 7.1 – Permissible currents in amperes for polyvinyl chloride (PVC) insulated conductors, for:

- Copper
- Conductor operating temperature: 70 °C
- Ambient temperature: 30 °C

Conductor nominal cross- sections (mm <sup>2</sup> )	Reference method			
	B 3 or 4 cables, three- phase AC	B 1 three-core cable (with or without protective conductor), or 1 four-core cable, three-phase AC	C (*) 3 or 4 cables, placed flat and close to each other, or placed in a triangle, three-phase AC	C (*) 1 three-core cable (with or without protective conductor), or 1 four-core cable, three-phase AC
1	12	11.5	14	13.5
1.5	15.5	15	18	17.5
2.5	21	20	25	24
4	28	27	33	32
6	36	34	43	41
10	50	46	59	57
16	68	62	79	76
25	89	80	104	96
35	110	99	129	119
50	134	118	167	144
70	171	149	214	184
95	207	179	261	223
120	239	206	303	259
150	262	225	349	299
185	296	255	400	341
240	346	297	472	403
300	394	339	545	464
400	467	402	634	557
500	533	–	723	–
630	611	–	826	–
800	–	–	943	–
1000	–	–	1058	–
Notes	* For $S \leq 16\text{mm}^2$ , circular conductors are assumed and for sizes $S > 16\text{mm}^2$ , sector shaped conductors are assumed (circular conductors are also applicable)			

**Annex 7.2 – Permissible currents in amperes for insulated conductors of cross-linked polyethylene (XLPE) or ethylene-propylene (EPR), for:**

- Copper
- Conductor operating temperature: 90 °C
- Ambient temperature: 30 °C

Conductor nominal cross-sections (mm <sup>2</sup> )	Reference method			
	B 3 or 4 cables, three-phase AC	B 1 three-core cable (with or without protective conductor), or 1 four-core cable, three-phase AC	C (*) 3 or 4 cables, placed flat and close to each other, or placed in a triangle, three-phase AC	C (*) 1 three-core cable (with or without protective conductor), or 1 four-core cable, three-phase AC
1	15	15	17.5	17
1.5	20	19.5	23	22
2.5	28	26	31	30
4	37	35	41	40
6	48	44	54	52
10	66	60	74	71
16	88	80	99	96
25	117	105	130	119
35	144	128	161	147
50	175	154	209	179
70	222	194	268	229
95	269	233	326	278
120	312	268	379	322
150	342	300	436	371
185	384	340	500	424
240	450	398	590	500
300	514	455	681	576
400	584	536	793	667
500	666	–	904	–
630	764	–	1033	–
800	–	–	1179	–
1000	–	–	1323	–
Notes	* For S ≤ 16mm <sup>2</sup> , circular conductors are assumed and for sizes S > 16mm <sup>2</sup> , sector shaped conductors are assumed (circular conductors are also applicable)			



Annex 7.3 – Permissible currents in amperes for polyvinyl chloride (PVC) insulated conductors, for:

- Copper
- Conductor operating temperature: 70 °C
- Ambient temperature: 30 °C

Conductor cross-sections(mm <sup>2</sup> )	Multicore cables	Single-core cables			
	Multicore cables, three phase AC (1)	Close to each other		Have a diametrical distance between each other (2)	
		Three cables, Flat placement, three phase AC	Three cables, Triangle placement, three phase AC	Three cables, Flat placement, three phase AC	
				Horizontal	Vertical
Reference method	E	F	F	F	F
1	14.5	-	-	-	-
1.5	18.5	-	-	-	-
2.5	25	-	-	-	-
4	34	-	-	-	-
6	43	-	-	-	-
10	60	-	-	-	-
16	80	-	-	-	-
25	101	114	110	146	130
35	126	143	137	181	162
50	153	174	167	291	197

70	196	225	216	281	254
95	238	275	264	341	311
120	276	321	308	396	362
150	319	372	356	456	419
185	364	427	409	521	480
240	430	507	485	615	569
300	497	587	561	709	659
400	597	689	656	852	795
500	-	789	749	982	920
630	-	905	855	1138	1070
800	-	1020	971	1265	1188
1000	-	1149	1079	1420	1337
Notes	<p>(1) For <math>S \leq 16\text{mm}^2</math>, circular conductors are assumed and for sizes <math>S &gt; 16\text{mm}^2</math>, sector shaped conductors are assumed (circular conductors are also applicable)</p> <p>(1) Pitch not less than the exterior diameter of single-core cable (<math>D_e</math>).</p>				

Annex 7.4 – Permissible currents in amperes for insulated conductors of cross-linked polyethylene (XLPE) or ethylene-propylene (EPR), for:

- Copper
- Conductor operating temperature: 90 °C
- Ambient temperature: 30 °C

Conductor cross-sections(mm <sup>2</sup> )	Multicore cables	Single-core cables			
	Multicore cables, three phase AC (1)	Close to each other		Have a diametrical distance between each other (2)	
		Three cables, Flat placement, three phase AC	Three cables, Triangle placement, three phase AC	Three cables, Flat placement, three phase AC	
Reference method	E	F	F	G	G
1	18	-	-	-	-
1.5	23	-	-	-	-
2.5	32	-	-	-	-
4	42	-	-	-	-
6	54	-	-	-	-
10	75	-	-	-	-
16	100	-	-	-	-
25	127	141	135	182	161
35	158	176	169	226	201
50	192	216	207	275	246

70	246	279	268	353	318
95	298	342	328	430	389
120	346	400	383	500	454
150	399	464	444	577	527
185	456	533	510	661	605
240	538	634	607	781	719
300	621	736	703	902	833
400	741	868	823	1085	1008
500	-	998	946	1253	1169
630	-	1151	1088	1454	1362
800	-	1275	1214	1581	1485
1000	-	1436	1349	1775	1671
Notes	<p>(2) For <math>S \leq 16\text{mm}^2</math>, circular conductors are assumed and for sizes <math>S &gt; 16\text{mm}^2</math>, sector shaped conductors are assumed (circular conductors are also applicable)</p> <p>(2) Pitch not less than the exterior diameter of single-core cable (<math>D_e</math>).</p>				

### Annex 7.5 – Use of aluminum conductors and busbars:

Under the same cross-sectional area, the current-carrying capacity of aluminum conductors is lower than that of copper conductors, and aluminum conductors with a larger cross-sectional area (generally increased by one to two levels) can be used to obtain the same current-carrying capacity as copper conductors.

In the aluminum-copper conductor interface, it must be properly processed or connected with the accessories specified by the manufacturer.

When copper busbars are used as rising wires, their thickness should not be less than 5mm<sup>2</sup>, and the current carrying capacity should be designed according to the manufacturer's technical data (current density (A/mm<sup>2</sup>)).

**ANNEX 8****CORRECTION FACTORS OF ELECTRICAL WIRINGS**

Annex 8.1 – Correction factors depending on ambient temperatures for electrical wirings installed in air.

Ambient temperature (°C)	Insulation	
	PVC	XLPE/EPR
30	1,00	1,00
35	0,94	0,96
40	0,87	0,91
45	0,79	0,87
50	0,71	0,82
55	0,61	0,76
60	0,50	0,71
65	-	0,65
70	-	0,58
75	-	0,50
80	-	0,41

Annex 8.2 – Correction factors for grouping cables of several circuits or several multicore cables, installed in the air, on the side, in a simple layer.

Ref.	Cable arrangement	Correction factors												Tables of admissible current in cables
		No. of circuits or multicore cables												
		1	2	3	4	5	6	7	8	9	12	16	20	
1	Inserted or embedded in building elements	1,00	0,80	0,70	0,65	0,6	0,57	0,54	0,52	0,50	0,45	0,41	0,38	1A, 1B 2A, 2B 3A, 3B
2	On the walls or floor or over paths of imperforated cable	1,00	0,85	0,79	0,75	0,73	0,72	0,72	0,71	0,70	The correction factor does not decrease for more than 9 cables.			1A,1B
3	On the ceilings	0,95	0,81	0,72	0,68	0,66	0,64	0,63	0,62	0,61				
4	In horizontal or vertical cable ducts	1,00	0,88	0,82	0,77	0,75	0,73	0,73	0,72	0,72				The correction factor does not decrease for more than 9 cables.
5	On stairs (for cables), consoles, etc.	1,00	0,87	0,82	0,80	0,80	0,79	0,79	0,78	0,78				

**ANNEX 9**

**DESIGNATIONS OF CONDUCTORS AND ISOLATED CABLES  
ACCORDING TO CENELEC HD361**

Example <sup>(1)</sup>				H	05	V		V			-F	3	G	2,5	
				Symbol											
NORMALIZATION	Type	Harmonized standards	H												
		Recognized national standards	A												
		Non-recognized national standards	PT-N												
RATED VOLTAGE		< 100/100 (V)	00												
		≥ 100/100 ; < 300/300 (V)	01												
		300/300 (V)	03												
		300/500 (V)	05												
		450/750 (V)	07												
		0,6/1 (kV)	1												
CONSTITUENTES		Insulation	Ethylene-propylene rubber	B											
			Ethylene vinyl acetate	G											
			Rubber	R											
			Silicone rubber	S											
			Venyl polychloride	V											
			Cross-linked polyethylene	X											
		Metal cladding or armor	Aluminum sheeting, extruded or welded	A2											
			Aluminum concentric conductor	A											
			Aluminum Shielding	A7											
			Steel tape armor, galvanized or not	Z4											
		Sheath	Ethylene vinyl acetate	G											
			Fiberglass braid	J											
Polychloroprene	N														
Rubber	R														
Textile braid	T														
Polyvinyl chloride	V														



CONSTRUCTION	Shape	Circular cabo							
		Flat cable							
		- divisible conductor	H						
		- non-divisible conductor	H2						
	Nature	Copper							
		Aluminium	-A						
	Flexibility	Flexible conductor, Class 5	-F						
		Flexible conductor, Class 6	-H						
		Flexible conductor or cable for fixed installations	-K						
		Rigid, circular conductor, stranded	-R						
		Rigid, sectorial conductor	-S						
Rigid, circular conductor, solid		-U							
Rigid, sectorial conductor, stranded		-W							
Tinsel condutor		-Y							
COMPOSITION <sup>(2)</sup>	Number de condutors								
	Without earthing condutor	X							
	With earthing condutor	G							
	Conductor cross-sections(mm <sup>2</sup> )								
	Identification by color								
	Identification by digit	N							
<p>(1) Harmonized cable, for insulated voltage of 300/500 (V), with polyvinyl chloride insulation. With class 5 flexible copper conductors, made up of three 2.5mm<sup>2</sup> conductors, one of which is the protection conductor (H05VV-F3G2.5).</p> <p>(2) When the cross-sections of neutral conductor and protective conductor are different from that of phase conductor, for example, a cable with 35mm<sup>2</sup> phase conductors and 16mm<sup>2</sup> neutral and protective conductors should be represented by 3x35 -2G16.</p>									

## ANNEX 10

### METER PANEL AND METER ROOM

#### 10.1 Electrical Connection

- In order to reduce the modification work when customers apply for increased power demand, all installation cables with a target load of 69 kVA or less should meet the requirements of section 4.5 of NCEM C14-100.
- In order to facilitate the installation and replacement of the power meter, all cables on the meter board (that is, all incoming and outgoing wires of the circuit breaker and the power meter) must pass through the power meter board at least 150 mm.
- Currently meter for small power consumer can be directly connected in-line between source and customer. Direct connected meter shall be installed for single-phase and three-phase four-wire with main switch rating up to and including 80 A.
- Indirectly connected meter where the electricity flows through a current transformer are used for larger loads, so that meter can be located other than in line with the service conductors. It shall be installed for three-phase four-wire low voltage installations with main switch rating exceeding 80A.
- It requires applying appropriate grip on all screws and is not allowed connecting more than one conductor to each terminal plate.
- The meter panel shall be sealed, so the screws should have a hole for CEM to seal.

#### 10.2 Metering Equipment Arrangement

The following items are the issues related to meter installation arrangement:

- Meter shall be installed in a clean and dry location which is not exposed to weather, extremes of temperature or mechanical damage, etc. and readily accessible

maintenance. It should also be as close as possible to the power supply point of the customer's facility.

- Appropriate and adequate lighting must be provided in the place where the meter is installed
- The meter room and metering equipment (including meters, circuit breakers and current transformer boxes) must be easily accessible from the public passage at any time without passing through individual units. The passageway and entrance to the meter room shall be at least 0.6 meters in width.
- All holes and wire pits on the floor of the meter room that pass through the floor must be properly sealed or covered to prevent the danger of falling from a height.
- Minimum size of the meter boards should be in accordance with NCEM C62-322.
- Adequate space shall be reserved to permit access to the metering installations and provide safety condition for reading access.
- The position of metering equipment shall be kept free of any obstruction and sufficient working space in front of the meter (as shown in Figure 10.1 for dimensional requirements and other details).

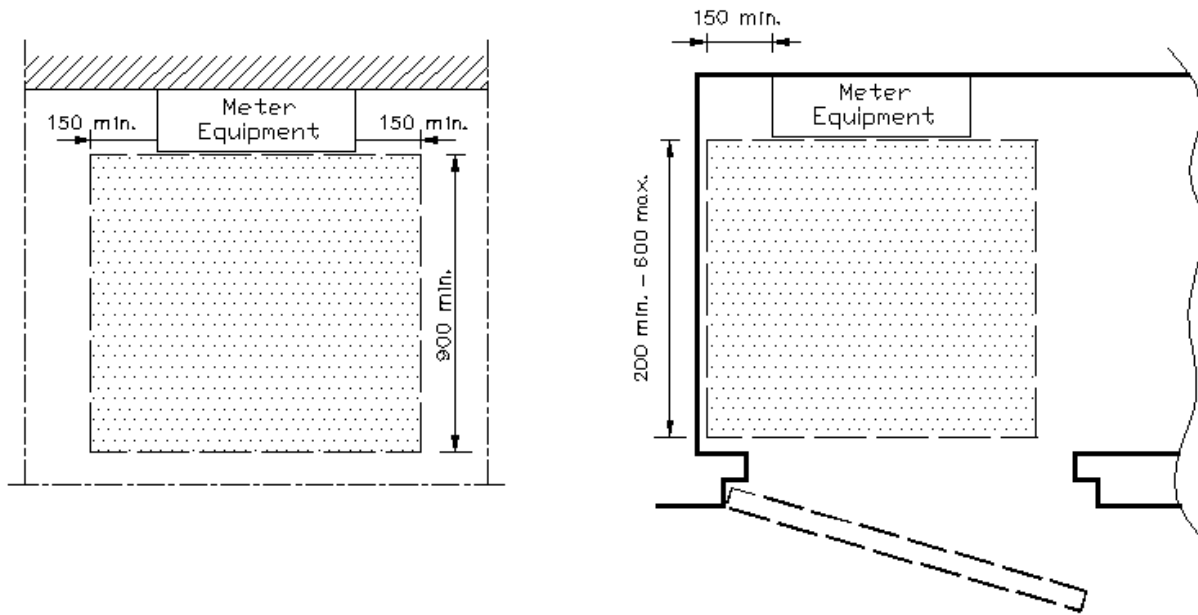

 Working Space;  
The indicated dimensions are in mm.

(a)

(b)

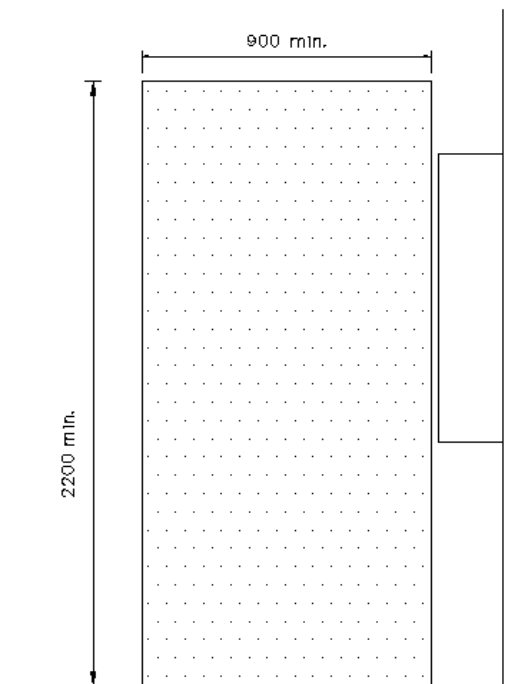

(c)

Figure 10.1 – Meter installed (a) in general region; (b) in electrical duct;  
(c) Working space in side view

*Note: Duct is an enclosed space for pipes accommodation, with dimensions that do not allow the movement of people but in which the installed pipes can pass throughout the space.*

- A legible and durable address label shall be fixed at each meter position. Flat numbering shall be from left to right, top to bottom in ascending order (refer to Figure 10.2).

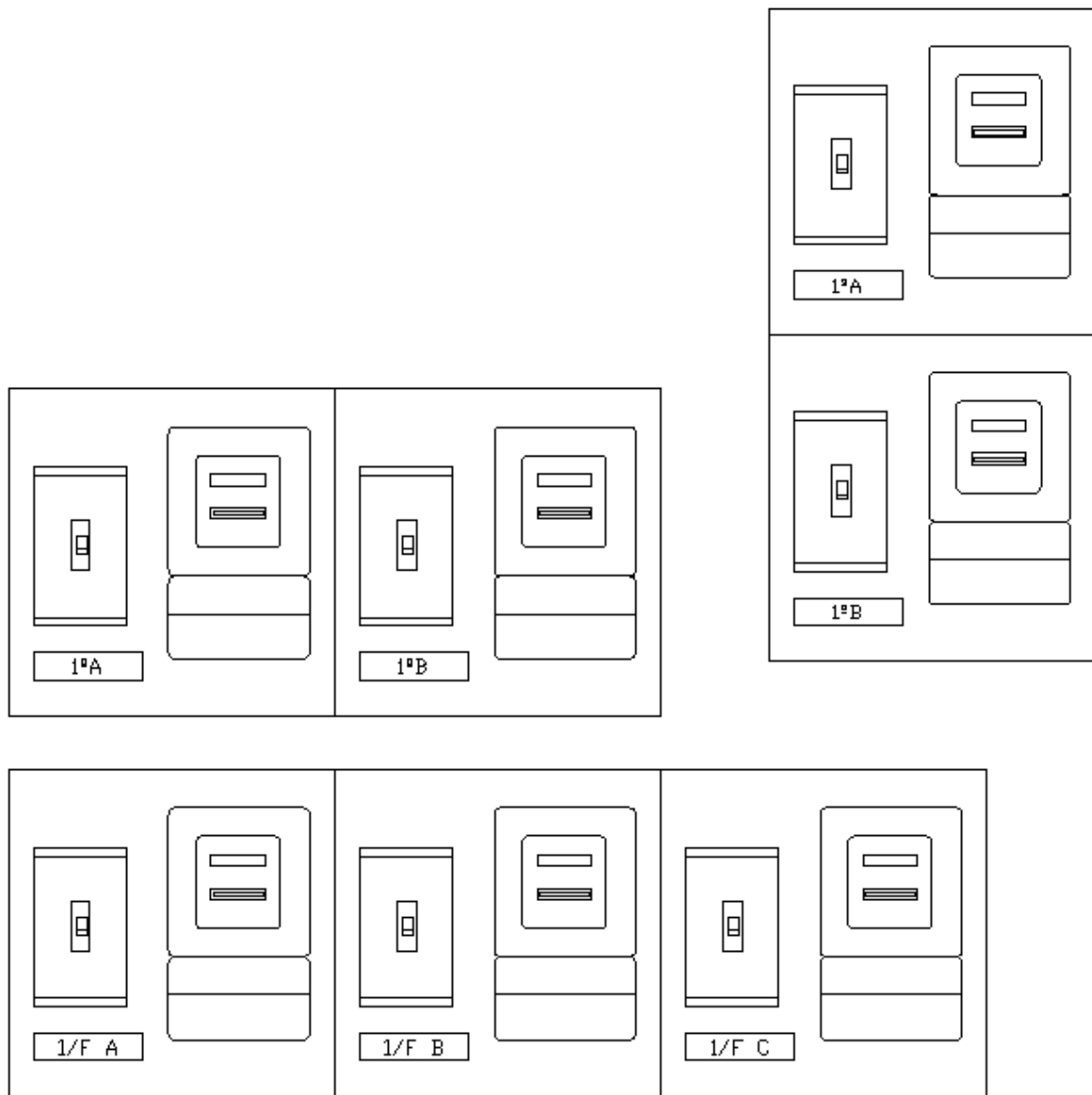

Figure 10.2 – Typical Meter Panel Arrangement

- A legible and durable identification label shall be provided at the cable termination near metering equipment to identify cable according to source and circuit number (refer to Figure 10.3).

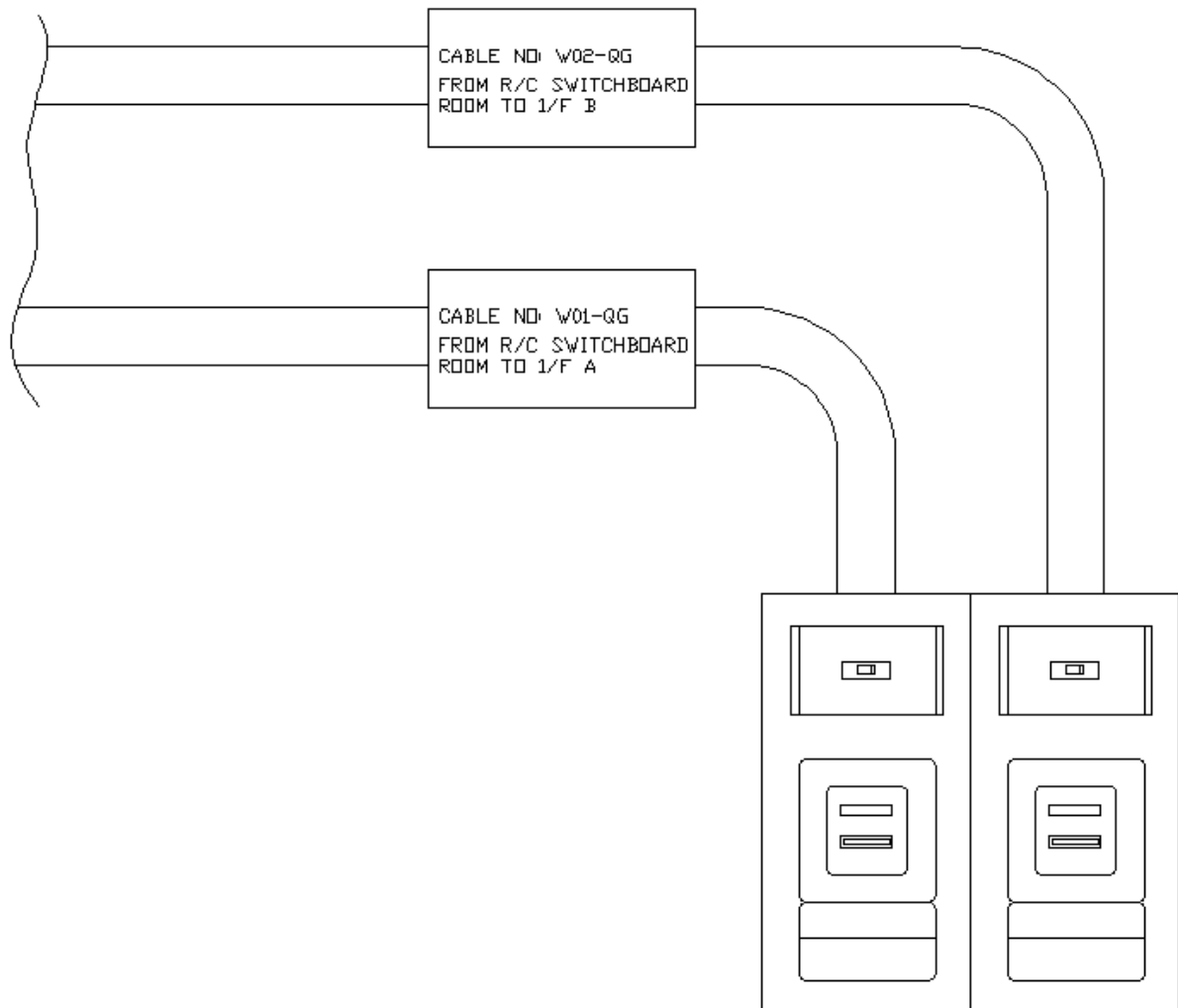

Figure 10.3 – Typical Cable Label

- The application of identification tapes or sleeves of appropriate colors (e.g. white with black letter/number) at terminations is also acceptable. Further, installing flame retardant or low smoke zero halogen cables, cable labels, tapes or sleeves should match the materials of cables.
- Engraved labels and paper labels with a cover sheet of rigid transparent plastic, tied-on or fixed on cables are also acceptable (refer to Figure 10.4).



(a)



(b)



(c)

Figure 10.4 - (a) Tie-on cable label; (b) Engraved tie-on cable label;  
(c) Wrap-around cable label

- The power meters of the following electric devices should be connected to the downstream position of the circuit breaker:
  - a) Power devices measured by current transformers
  - b) Power installations directly connected to the CEM grid (that is, there is no protection device installed by the customer or that is a public part of the building upstream of the power installation)

In addition to the above, the power meter should be connected to the upstream position of the circuit breaker.

- Meter shall be installed close to the supply point of the electrical installation or the supply point.
- Display of meter shall be installed at a position not less than 1.0 m nor more than 1.70 m above the floor.
- If the area with a higher risk of flooding and there is no suitable location outside the ground floor, you can consider installing the metering equipment (including meters, circuit breakers and current transformer boxes) in a higher location, but needs to pass through CEM in advance Approval. In this case, in order to facilitate the meter reading, the meter should be installed on the meter board.



## ANNEX 11

Below are introduced three type of supply methods as an alternative for pothead use to supply commercial premises of new buildings:

- a) Supply of commercial unit through building common area

Supply cable shall be installed in building common area/pathway (as per definition by DSSCU). Therefore, common pathway shall be ready for circulation around the commercial unit for locating the supply cable.

- b) Supply of commercial unit through ducting attached to the façade of the building

VD110 ducting embedded in concrete to be attached to the façade of building during the construction time for cable passing. The cable crossing box allows the cables to pass through and connects to the distribution box of the store. However, this method comes with a limitation of which can only be applied to building with R/C floor high not less than 4.2 m.

- c) Supply of commercial unit through embedded ducting in shopfront

Embedded VD110 ducting during the construction time for cable passing. The cable crossing box allows the cables to pass through and connects to the distribution box of the store.

## ANNEX 12

### Anti-flood requirements for electrical facilities

Electrical facilities must comply with the following anti-flood design requirements to minimize flood risks and damage to the network equipment and to the building installation:

1. The mounting height of the pothead box (if existing) should be defined on a case by case basis according to the building location. For all cases, the minimum mounting height above finished level (AFL) should be 1.5 m.
2. Electrical facilities such as customer substations, customer QG or QC, all collective installations elements and metering boards or boxes **must be located above the flood proofing elevation defined by DSSCU**, without compromising operational and safety requirements as defined by the present CEM specification and the regulations in force, and to be approved on a case by case basis.
3. If the QG or QC is located on the ground floor at an inaccessible operating height, the building must be equipped with a waterproof remote control device installed on the ground-floor at an accessible height, near the building main entrance or in doormen or security counters or rooms, to disconnect the power in case of emergency. The remote control device should be installed in a box protected by a transparent cover to prevent accidental touch, and be equipped with the following label: Emergency Button — Power Interruption.
4. In the buildings supplied without pothead nor customer substation, when the elevation level defined in 2. determines the installation of the QG or QC above the ground floor, an additional main circuit breaker should be installed close to the main entrance of the building. The QC or QG and the meters must be installed inside a compartment. The cable between the additional circuit breaker and the QG or QC is under customer responsibility.
5. If the additional main circuit breaker referred in point 4 is located at an inaccessible height, the building must have a waterproof remote control as defined in paragraph 3.
6. Emergency lighting supported by batteries or emergency generators must be provided.



# TECHNICAL SPECIFICATION

NCEM 1.62.002

June 2022

Collective Line Distribution Box

## Contents

<b>1</b>	<b>Application field</b> .....	<b>3</b>
<b>2</b>	<b>Rated values</b> .....	<b>3</b>
<b>3</b>	<b>Constructive features</b> .....	<b>3</b>
3.1	Generalities.....	3
3.2	Enclosure.....	3
3.3	Types of boxes.....	5
3.4	Electrical equipment.....	6
3.5	Marking.....	7
<b>4</b>	<b>Accessibility</b> .....	<b>7</b>

## **1 Application field**

This section applies to the distribution boxes of the building's collective installations whose purpose is to supply residential and commercial premises where electricity is supplied in low voltage by CEM.

It is admitted that the distribution boxes for the modification of old installations may have constructive characteristics different from those specified in this document, provided that the utilization of the boxes is practically impossible. In any case, the distribution boxes to be installed shall be subject to the prior approval of CEM.

## **2 Rated values**

- Rated voltage: 1 kV
- Number of phases (incoming and outgoing): 3

## **3 Constructive features**

### **3.1 Generalities**

The collective line distribution boxes shall be designed and constructed in such a way as to ensure their perfect functioning and the necessary safety conditions in normal use.

### **3.2 Enclosure**

- Materials

The enclosure of the distribution boxes shall be made of metal sheet, polyester or other suitable material. The enclosure shall be flame retardant and shall be used under temperature between -5 °C and +70 °C.

The boxes shall comply with the tests specified in IEC 61439-2.

- Surface protection

When executed in galvanized steel plate, the galvanizing thickness shall not be less than 20  $\mu\text{m}$ . A zinc-rich primer coating (zinc powder or zinc chromate), a wash-primer coating and a finish enamel coating should be applied successively to a carefully cleaned and degreased sheet. A coating of finish marine type enamel shall be applied (Transocean Marine Paint, Hammer-Tone finish, color 916-05, or equivalent type from another manufacturer, but of similar color).

When executed in stainless steel sheet, a suitable primer coating and an enamel coating mentioned above shall be applied to the carefully cleaned and degreased surface.

In all cases, all bolts, washers and nuts shall be of stainless material or protected by zinc plating or electrolytic plating of minimum 12  $\mu\text{m}$  thickness applied before assembly. After assembly, all screws should be painted with a finishing coating.

When executed in aluminum alloy, the surface should be protected by anodizing or another process that guarantees protection against corrosion for a period not less than 10 years.

- Opening for passage of electrical conduits

The circular grooves for passage of electrical conduits shall be painted, immediately after their execution, with one primer coating of the type used in the paint of the collective line distribution box, when it is in steel.

The passage of the electrical conduits will be carried out using nozzles or stoppers for tube, according to cross-sections of tube, and in thermoplastic material. For multicore cable, it will be carried out using cable glands of suitable diameter.

- Degree of protection

For outdoor mounting, the distribution box should have a degree of protection not less than IP43 and IK07 as defined in IEC 60529 and IEC 62262 respectively.

### 3.3 Types of boxes

Two types of boxes are considered:

- Type CCL 500 (J120-A) – allows the execution up to four three-phase outgoing or six single-phase outgoing.

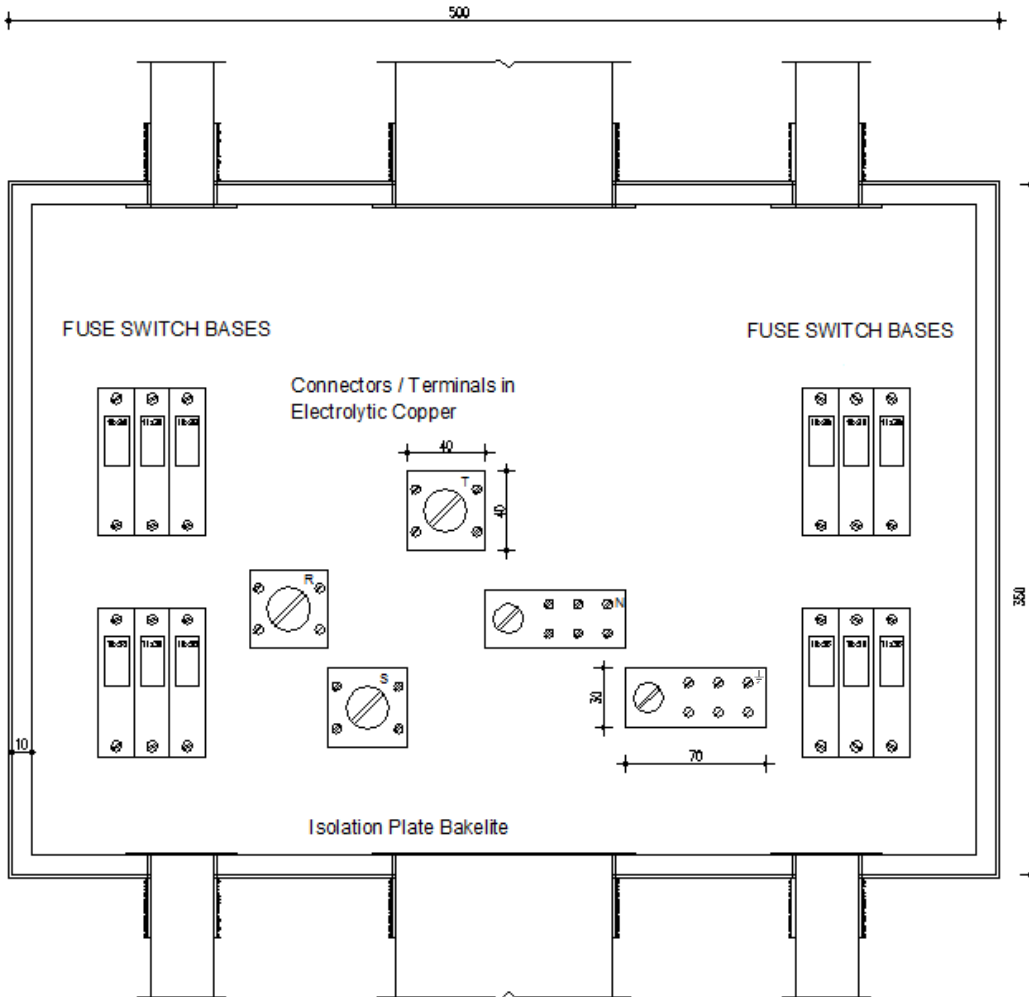

Figure 1 – Typical drawing of distribution box type CCL 500

Distribution boxes shall comply with those indicated in the above figures, considering that the internal dimensions are understood as minimum.

The door, the hinges and the sealed locking system shall be of the type indicated in the drawings.

### 3.4 Electrical equipment

- Generalities

Distribution boxes are provided for one incoming and one or more outgoings of electrical wires, allowing the assembly of the required connectors and the short-circuit protection devices of the phase conductors, consisting of fuse with or without fuse cartridges.

The protective conductor of the distribution boxes and the incomings should be placed inside the distribution box so that they will not be in contact with the live parts even if the conductors are separated or detached from the connectors.

- Connectors

The connectors for copper conductors shall be of tinned copper.

The connectors for tightening the conductors of the collective line shall allow the fixing of the conductors without interruption and allow the connection of copper conductors up to 35 mm<sup>2</sup> cross-section. The tightening of each conductor shall be independent.

The connectors shall be strong enough not to deform during the tightening or loosening of the conductors and shall be of adequate size to the nominal sections of the conductors to be used.

When the phase and neutral connectors do not have an isolated mounting base, they shall be mounted on a plate of insulation material which ensures insulation in relation to ground and between phases and also ensures the necessary mechanical strength.

The connectors should be located so that the placement of the conductors and their tightening are easy.

Neutral connectors should be located below and to the right of the phase connectors.

The protective earth (ground) connector should be located below the neutral connectors and be electrically connected to the earth of the distribution box.



- Fuse

The cut-off device installed in the distribution box shall consist of fuse switch with cylindrical type aM fuse (IEC 60269-1 and 2), with high breaking capacity and with nominal current adequate to the protection of outgoings.

### 3.5 Marking

Inside distribution box, the neutral connector shall be identified by the symbol N and the protection earth (ground) connector shall be identified by the symbol



. These markings should not be placed on the bolts, nuts, washers or other removable parts.

The markings should be made in an indelible, unambiguous and easily readable form.

CCL box must be provided with the following label: "ACCESS TO CCL CANNOT BE BLOCKED".

## 4 Accessibility

CCL boxes should be easily accessible to CEM staff and should be installed, as a rule, between 2 m and 2.8 m above the floor, and the front working space shall not be less than 900mm.

The CCL box shall be embedded or firmly installed on the vertical wall or the structure of the building, and the hinges shall be opened to a minimum of 90 degrees.



# TECHNICAL SPECIFICATION

NCEM 1.62.003

June 2022

Main Collective Switchboard

## Contents

<b>1</b>	<b>Application field</b> .....	<b>3</b>
<b>2</b>	<b>Rated values</b> .....	<b>3</b>
<b>3</b>	<b>Constructive features</b> .....	<b>3</b>
3.1	Generalities .....	3
3.2	Location .....	3
3.3	Constitution .....	4
3.4	Enclosure .....	5
3.5	Types of switchboard.....	6
3.6	Electrical equipment .....	8
3.7	Marking .....	10

## 1 Application field

This section applies to the main collective switchboard of the collective installations of buildings whose purpose is to feed residential and commercial premises where electricity is supplied in low voltage by CEM.

It is admitted that the main collective switchboard for the modification of old installations may have constructive characteristics different from those specified in this document, provided that the utilization of the switchboard is practically impossible. In any case, the switchboard to be installed shall be subject to the prior approval of CEM.

## 2 Rated values

- Rated Voltage: 1kV
- Number of phases: 3

The values of the rated currents are as follows:

32 A, 63 A, 100 A, 125 A, 250 A, 400 A, 630 A, 800 A, 1250 A,  
corresponding to the nominal current of main switch cubicle switchboard.

## 3 Constructive features

### 3.1 Generalities

In principle, each building shall be provided with a main collective switchboard. In duly justified cases, this provision may be waived, but there should be a clear indication in each collective switchboard of the existence of other collective switchboard.

### 3.2 Location

Main collective switchboard shall be installed within the building, as close as possible to its normal access and to the relevant potheads, if any.

Main collective switchboard shall be in a location such that an accident occurring inside the switchboard cannot obstruct the evacuation of personnel or the organization aids under any circumstances.

Main collective switchboard shall be installed in a suitable location and easily accessible so that the devices mounted thereon are easily accessible from the ground.

If the building is located in a low-lying flooding area (as defined by MSAR Government), the installation height of the main collective switchboard should meet the requirements defined in Annex 12 of NCEM C14-100.

### 3.3 Constitution

Main collective switchboard shall consist of cubicles, suitably grouped, which, depending on the apparatus and other components contained therein, are designated by:

- Main switch cubicle switchboard (CCG);
- Busbar cubicle switchboard (CBR);
- Riser protection cubicle switchboard (CPS).

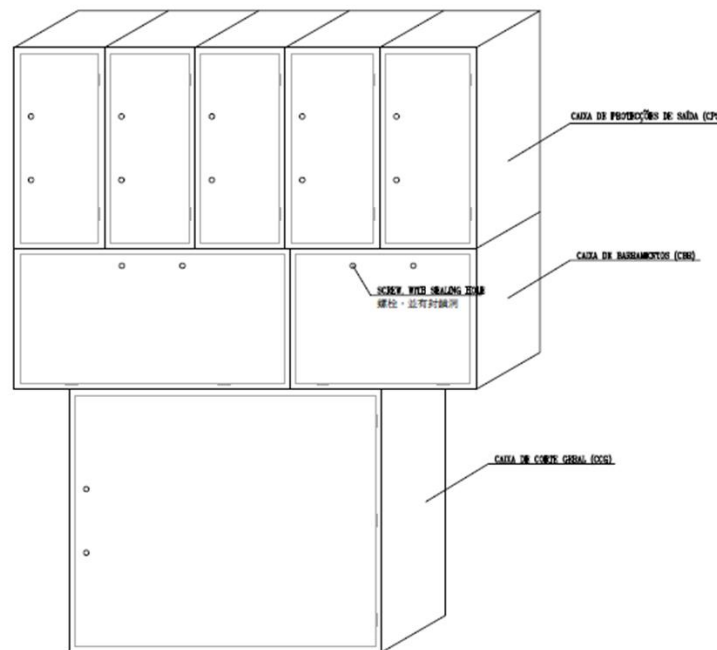

Figure 1 – Typical drawing of main collective switchboard

A single main switch cubicle switchboard should be, obligatorily, part of the main collective switchboard.

### 3.4 Enclosure

- Materials

Enclosure of switchboards shall be made of metal sheet, polyester or other suitable material. The enclosure shall be flame retardant and shall be used under temperature between -5 °C and +70 °C.

Note: In addition to the usual measures to protect against severe weather conditions in Macau, it is suggested to use polyester reinforced with fiberglass enclosure to avoid rust.

The switchboards shall comply with the test specified in IEC 61439-2.

- Surface protection

When executed in galvanized steel plate, the galvanizing thickness shall not be less than 20 µm. A zinc-rich primer coating (zinc powder or zinc chromate), a wash-primer coating and a finish enamel coating should be applied successively to a carefully cleaned and degreased sheet. A coating of finishmarine type enamel shall be applied (Transocean Marine Paint, Hammer-Tonefinish, color 916-05, or equivalent type from another manufacturer, but of similar color).

When executed in stainless steel sheet, a suitable primer coating and an enamel coating mentioned above shall be applied to the carefully cleaned and degreased surface.

In all cases, all bolts, washers and nuts shall be of stainless material or protected by zinc plating or electrolytic plating of minimum 12 µm thickness applied before assembly. After assembly, all screws should be painted with a finishing coating.

When executed in aluminum alloy, the surface should be protected by anodizing or another process that guarantees protection against corrosion for a period not less than 10 years.

- Incoming and outgoing

Main collective switchboards allow one or more incoming and outgoing conduits.

The incoming and outgoing conduits shall be on opposite horizontal faces and shall be fitted with appropriate fixing and sealing elements for the conduits.

The passage of the electrical conduits will be carried out using nozzles or stoppers for tube, according to cross-sections of tube, and in thermoplastic material. For multicore cable, it will be carried out using cable glands of suitable diameter.

- Interior accessibility

The boxes of main collective switchboard shall be provided with a door in accordance with attached figures. The doors will be provided with 2 inner hexagon head screw with sealing hole according to the same figures. The hinges shall be of the type indicated also in the attached figures.

- Degree of protection

For outdoor mounting, the switchboard should have a degree of protection not less than IP43 and IK07 as defined in IEC 60529 and IEC 62262 respectively.

### **3.5 Types of switchboard**

- Main switch cubicle switchboard (CCG)

The main switch cubicle switchboard shall contain a 4-pole isolating switch, which shall comply with the provisions in Section 3.6.

The following types of main switch cubicle switchboards are adopted:

- Type CCG 400,
- Type CCG 750.

- Busbar cubicle switchboard (CBR)

The cubicle switchboards are intended to contain the elements necessary for the interconnection of main switch cubicle switchboard and riser protection cubicle switchboard or the interconnection of more than one door to the main switch cubicle switchboard.

The following types of busbar cubicle switchboards are adopted:

- Type CBR 750
  - Type CBR 1000
- 
- Riser protection cubicle switchboard (CPS).

The riser protection boxes are intended to contain overcurrent protection devices consisting of fuses or circuit breakers which comply with Section 3.6.

The following types of riser protection cubicle switchboards are adopted:

- Type CPS 250

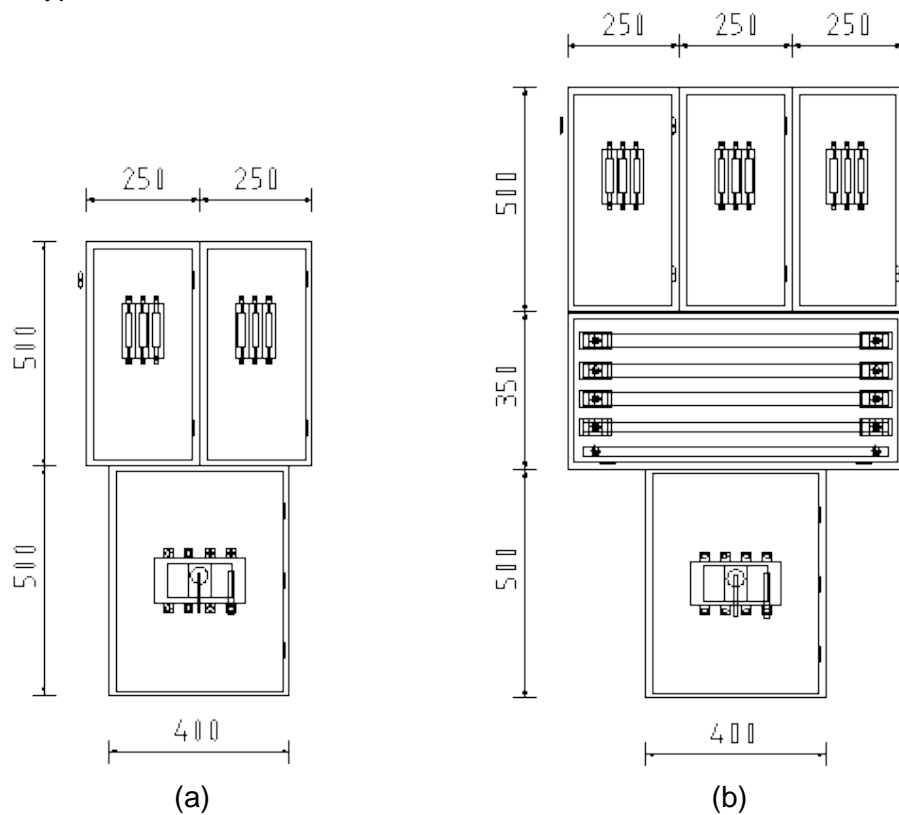



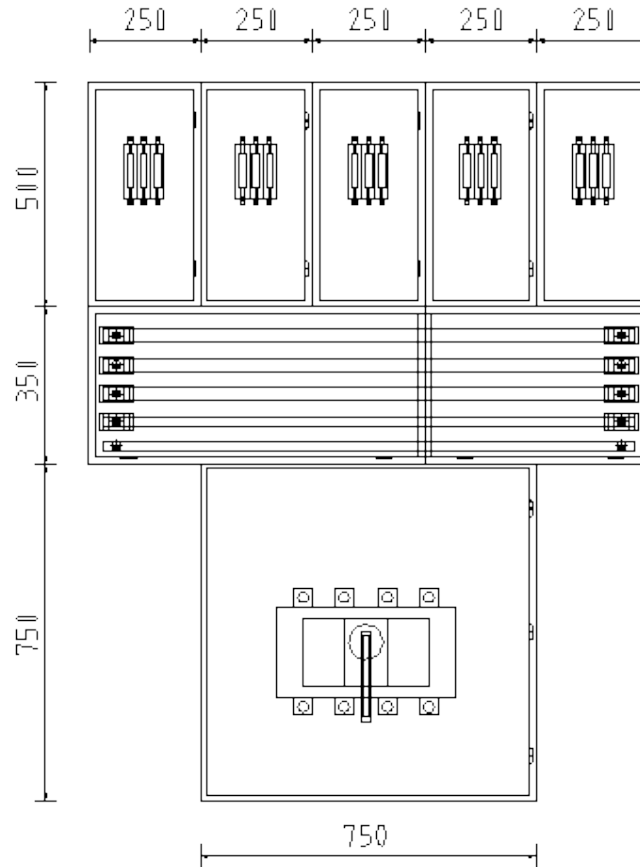

(c)

Figure 2 – Main collective switchboard with (a) 2 outgoing; (b) 3 outgoing; (c) 5 outgoing

### 3.6 Electrical equipment

- Isolating switch

Main isolating switch must be 4-pole, with visible break or positive contact indication, class AC22, must comply with the provisions of IEC 60947-3, and the nominal current must be adequate to the power to be supplied.

- Connectors

The connectors for copper conductors should be tinned copper.

The connectors for aluminum conductors shall be of tinned aluminum or an alloy that does not give rise to the appearance of electrolytic corrosion phenomena in the contact between metals. In these connectors, the entire contact zone should be covered with neutral grease of drop point higher than 105°C.

The aluminum-copper transition connectors shall be of the bimetallic or alloy type which does not give rise to electrolytic corrosion phenomena in the contact between metals. In these connectors the contact zone should also be covered with neutral grease of drop point higher than 105 °C.

The connectors shall be sufficiently robust not to deform as to the tightening or loosening of the conductors and shall be of adequate size to the nominal sections of the conductors to be used.

The connectors should be located so that the placement of the conductors and their tightening are easy.

The neutral connectors should be located to the left of the fuse of the collective line or entrance-service line to which they correspond.

The earth (ground) connector should be located below the neutral connectors and be electrically connected to the earth of the collective switchboard.

- Fuses

The cut-off device to be installed in the riser protection cubicle switchboards shall consist of single pole or three-pole bases and fuse size 00, 0 or 1 (IEC60269-2), of high breaking capacity and with nominal intensity adequate to the protection of the outgoing conduits.

In the case of riser protection cubicle switchboards, if, after the fuses have been inserted, the distance between active parts with different polarity is less than 30 mm, a fixed insulating separator with suitably dimensioned should be used in such a way as to avoid possible contact between these parts.

These separators should be extended in order to separate the fuse connectors from each other.

- Protection conductors

The main protective conductor and outgoing protective conductors should be placed inside the main collective switchboard so that they will not be in contact with the live parts even if the conductors are separated or detached from the connectors.

### 3.7 Marking

Inside the enclosures of the collective switchboards, the neutral connector shall be identified by the symbol N and the protection earth (ground) connector shall be identified by the symbol  $\perp$ . These markings should not be placed on the bolts, nuts, washers or other removable parts.

The markings should be made in an indelible, unambiguous and easily readable form.

The switchboard must be provided with the following label: 「有電危險 Danger - Electricity Perigo - Eletricidade」.

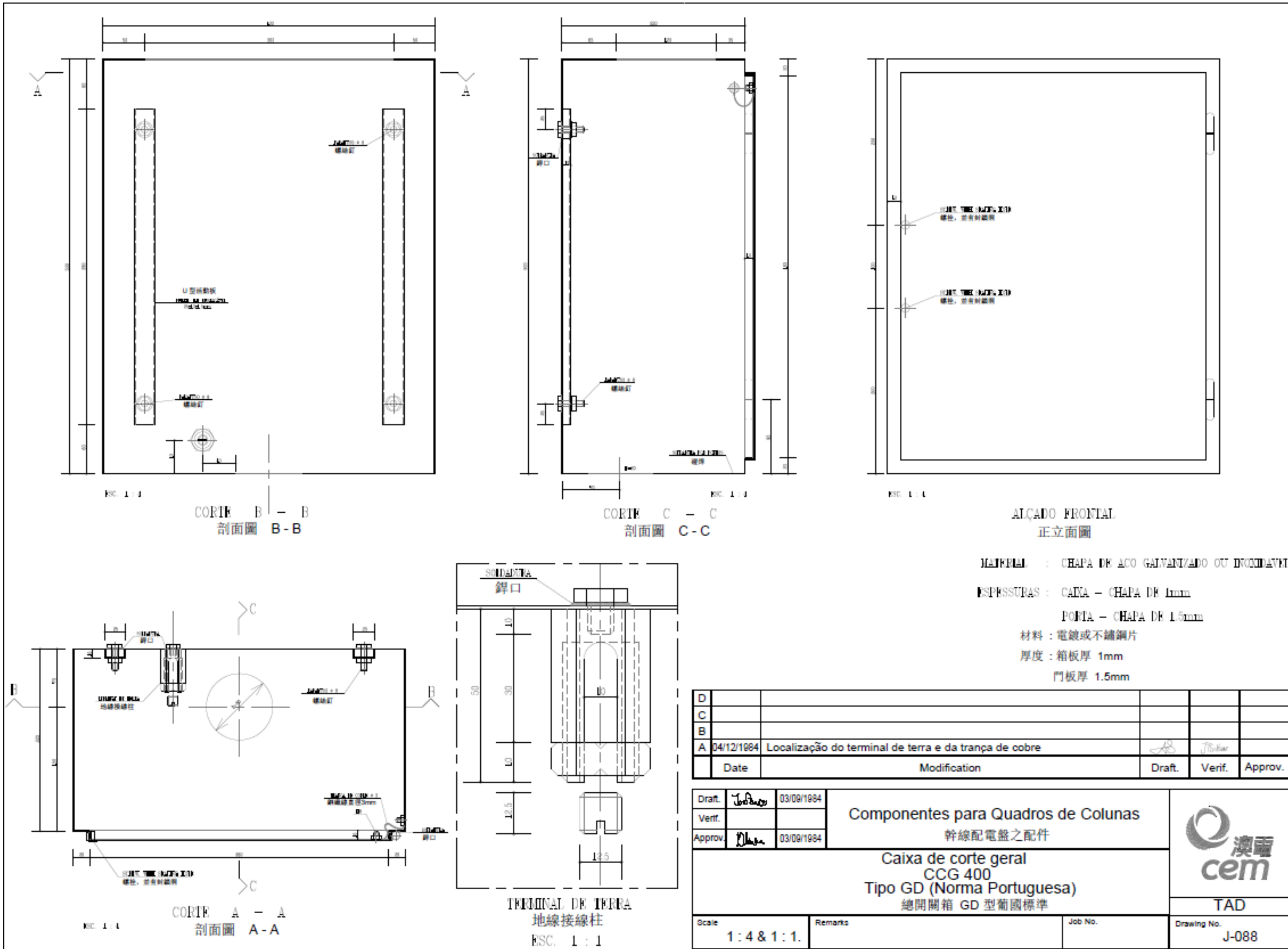

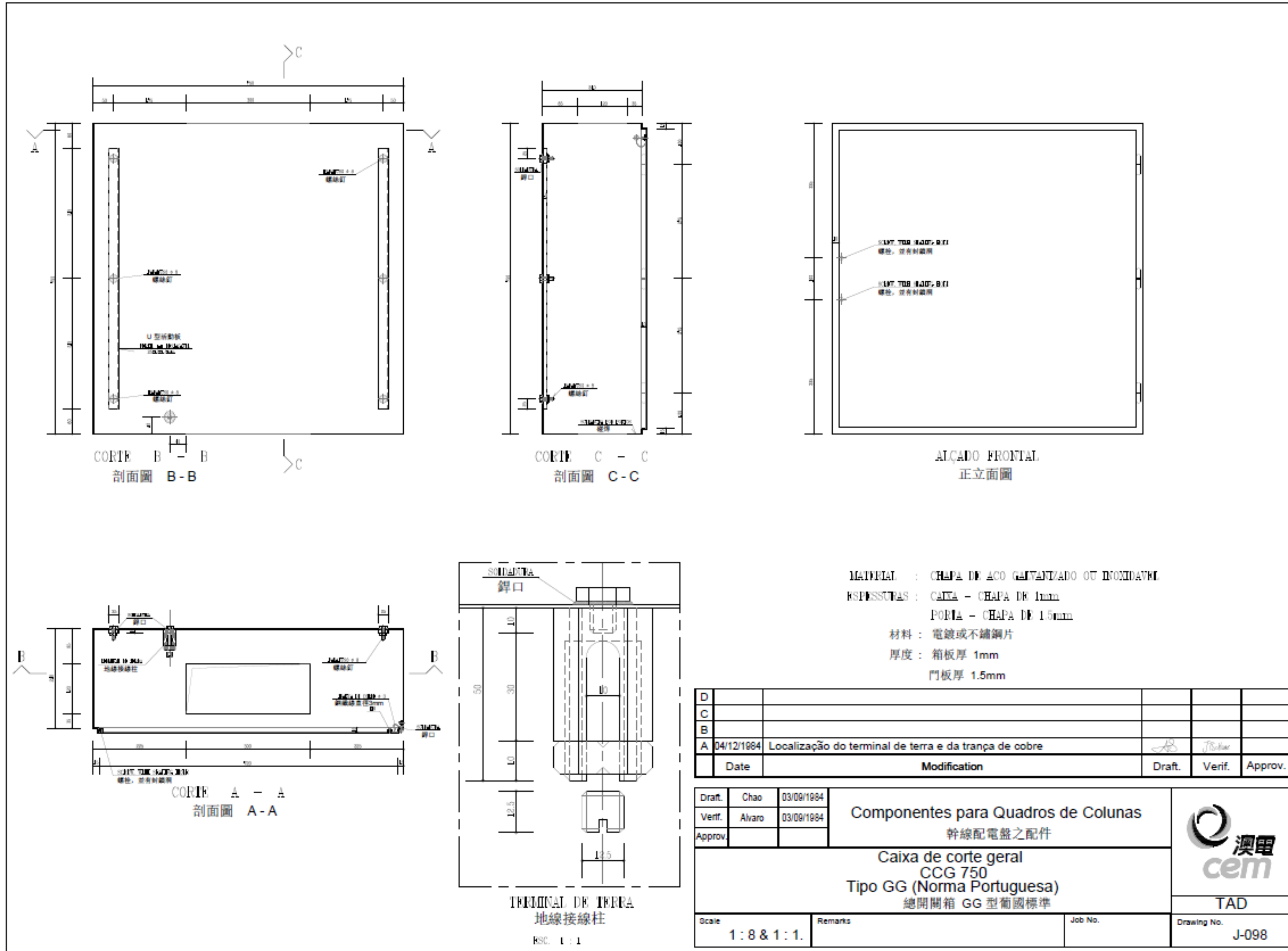

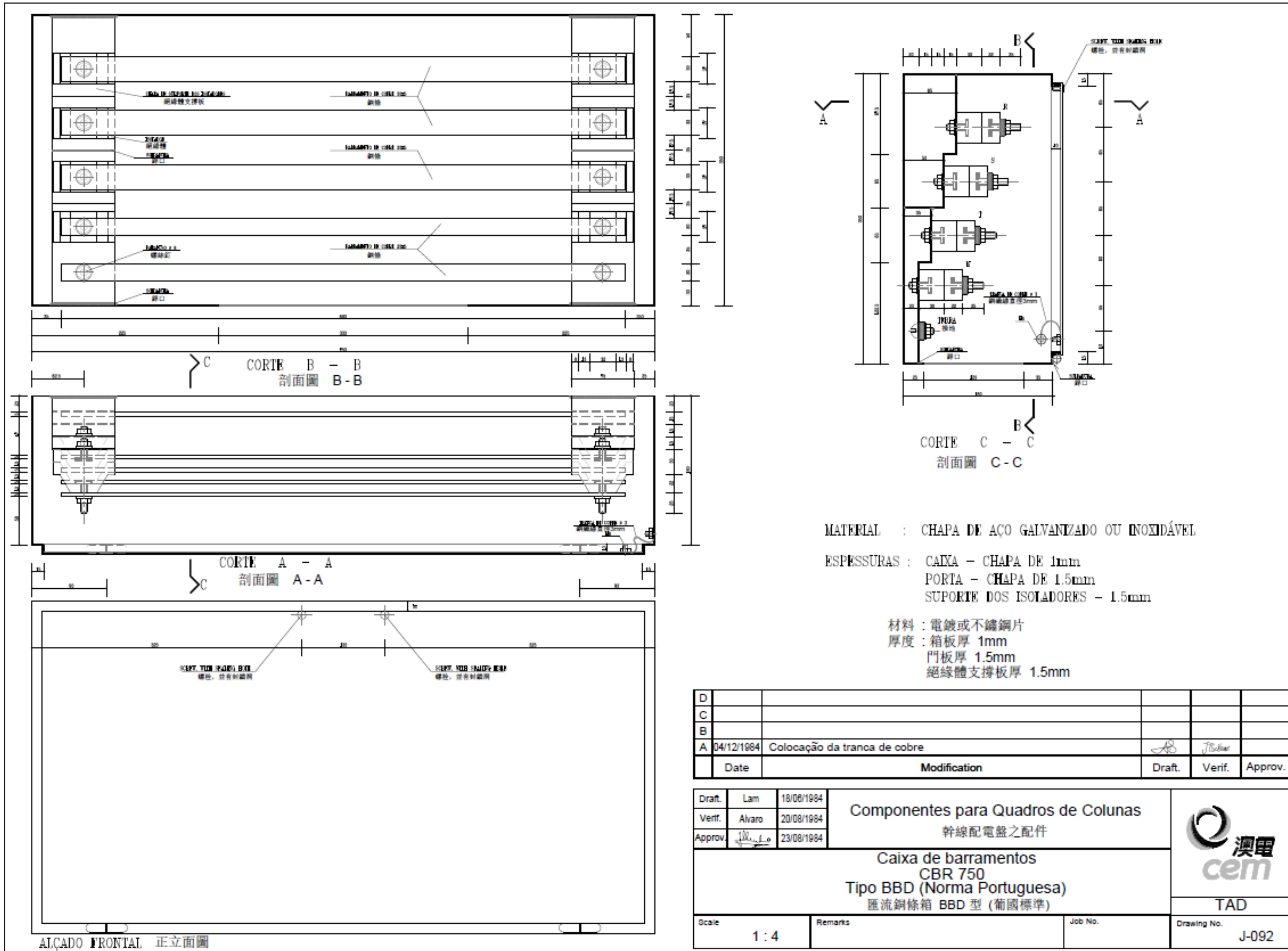

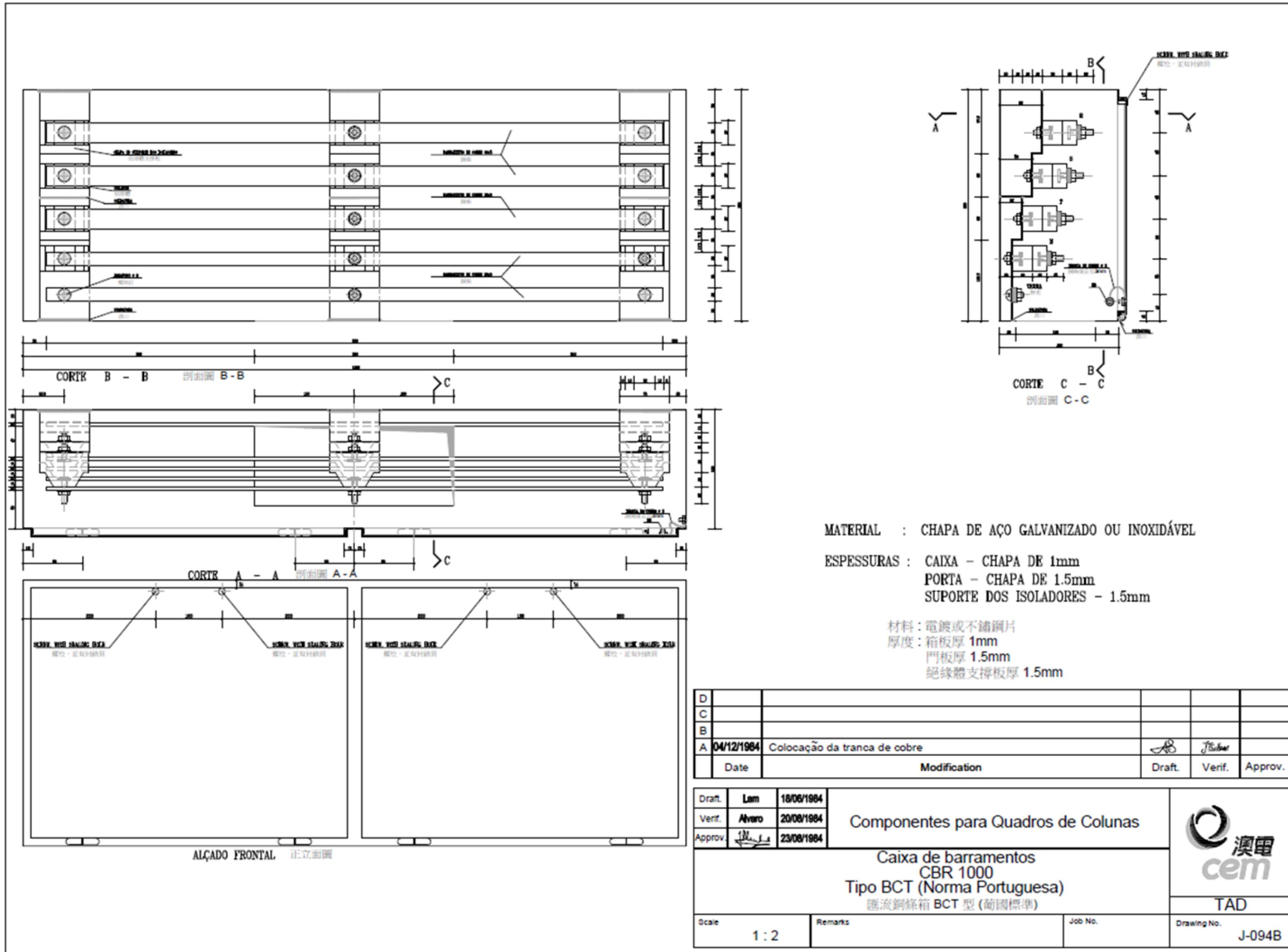







# TECHNICAL SPECIFICATION

NCEM C62-315

June 2022

**Box for Current Transformer**

## Contents

1.	Application field .....	3
2.	Rated values .....	3
3.	Conditions of installation.....	3
4.	Constructive features .....	3
4.1	Generalities.....	3
4.2	Types of boxes .....	3
4.3	Constitution .....	4
4.4	Enclosure .....	4
	Compartments for Current Transformers .....	6
	Type CTI 252 .....	8
	Type CTI 302 .....	12
	Type CTI 352.....	16
	Installation examples.....	20

## 1. Application field

This specification applies to the boxes for the installation of current transformers used for energy metering where electricity is supplied in low voltage by CEM.

These boxes are referred to briefly as "CTI".

## 2. Rated values

- Rated voltage: 1 kV
- Number of phases: 3

The rated currents are:

200 A, 400 A, 600 A,

corresponding to the maximum rated currents of current transformers which can be installed.

## 3. Conditions of installation

CTI's shall be located close to the customer main switchboard, so that the equipment is in an easily accessible position from the floor.

Attached figures give indications on the layout of CTI's. These examples are not restrictive in terms of the number of outgoing.

## 4. Constructive features

### 4.1 Generalities

The boxes shall be designed and constructed in such a way as to ensure, in normal use, the correct operation of the equipment installed inside and to ensure the necessary safety conditions.

### 4.2 Types of boxes

For the purpose of this section, the following types of boxes are considered:

- Type CTI 252 - Box for current transformer,  $I_n \leq 200A$ , where the incoming and outgoing connector is in insulated cables;
- Type CTI 302 - Box for current transformer,  $I_n \leq 400A$ , where the incoming and outgoing connector is in insulated conductors or cables;
- Type CTI 352 - Box for current transformer,  $I_n \leq 600A$ , where the incoming and outgoing connector is in insulated conductors or cables;

The boxes shall comply with those indicated in attached figures, considering that the

indicated dimensions are understood as minimum.

The door, hinges and sealing system shall be of the type indicated in the attached figures.

Type of Box	Enclosure		
	Width	Height	Depth
CTI 252	250	500	190
CTI 302	300	500	190
CTI 352	350	500	190

### 4.3 Constitution

The CTI's are made up of two distinct parts:

- a) Enclosure, intended to ensure protection of the equipment installed therein;
- b) Installation plate equipped with the necessary equipment for the installation of the current transformers, and which attaches to the enclosure in a removable way.

### 4.4 Enclosure

- Materials

The enclosure of the box shall be made of metal sheet, polyester or other suitable material. In case of galvanized sheet steel, it is required a minimum 1.5 mm thickness and a galvanizing thickness not less than 20  $\mu\text{m}$ .

- Protection against corrosion

The enclosure should be protected against corrosion by observing the following:

- A zinc-rich primer coating (zinc powder or zinc chromate), a wash-primer coating and a finish enamel coating should be applied successively to the carefully cleaned and degreased sheet. A coating of finish marine type enamel shall be applied (Transocean Marine Paint, Hammer-Tone finish, color 916-05, or equivalent type from another manufacturer, but of similar color).

The hinges, screws, nuts and washers should preferably be of stainless material or be effectively protected against corrosion by galvanizing and passivation.

- Opening for passage of electrical conduits

The opening for passage of electrical conduits should be painted, immediately after its execution, with a coat of primer of the type used in the painting of the boxes.

The passage of the conduits will be carried out:

- a) For tube, nozzles or stoppers are used with suitable cross-section of the tube, and are in thermoplastic material;
- b) For multicore cable, glands of adequate diameter are used;
- c) For single core cable, glands of suitable diameter are used and applied on a bakelite plate, fixed by an appropriate device to the respective CTI;
- d) For copper bar from CPS, bakelite plate are used as busbar support and with opening for passage of neutral and protective conductors, fixed by device appropriate to the respective CPS.

- Installation plate

The installation plate should have the shape and dimensions indicated in the attached figures. The plate is constructed of bakelite with a minimum 5 mm thickness.

- Apparatus

The apparatus required the installation of current transformers should be as shown in the attached figures.

- Electrical equipment

The CTI's are intended to contain the measurement transformers to be supplied by CEM, namely the low voltage current transformers to be used with electric energy meters.

# Compartments for Current Transformers

Enclosure  
(dimensions in mm)

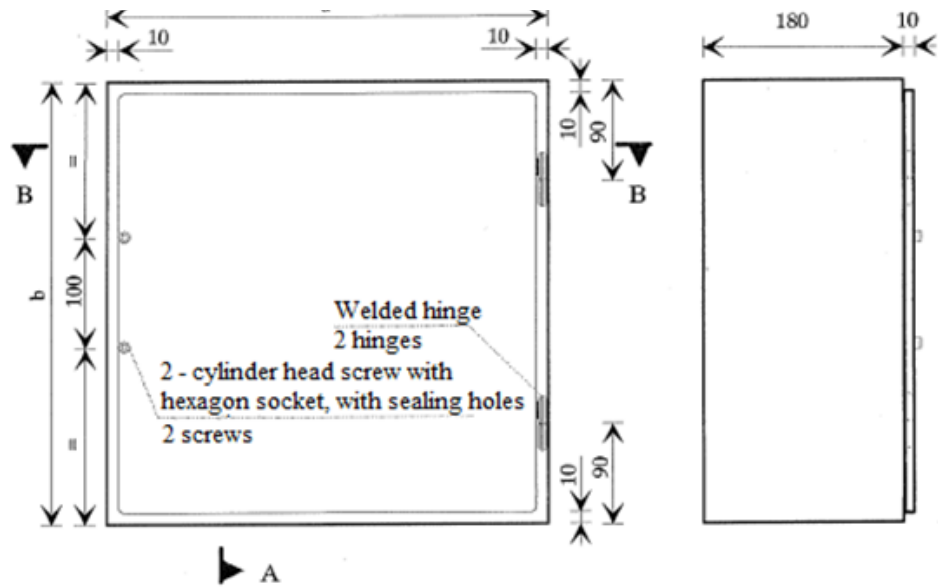

A

Front View

Side View

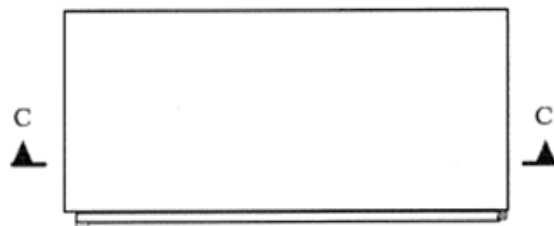

C

C

Top View

	a	b
CTI 252	250	500
CTI 302	300	500
CTI 352	350	500

Enclosure  
(dimensions in mm)

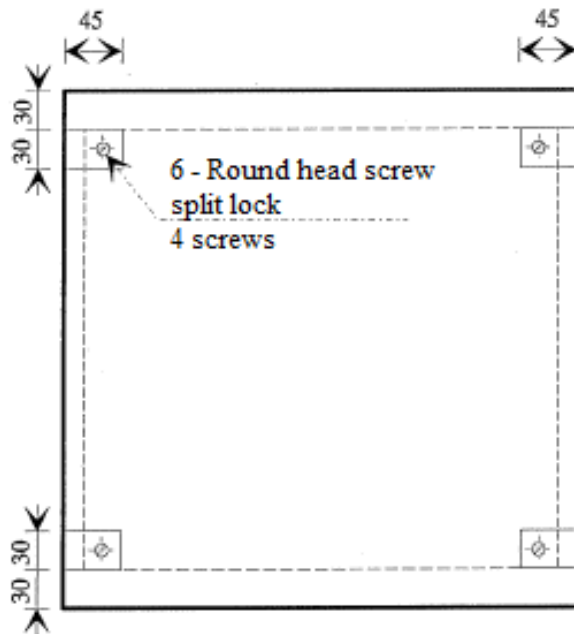

Section C-C

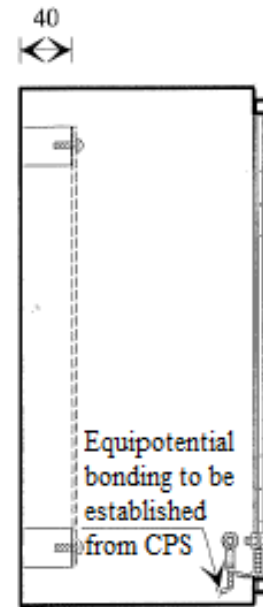

Section A-A

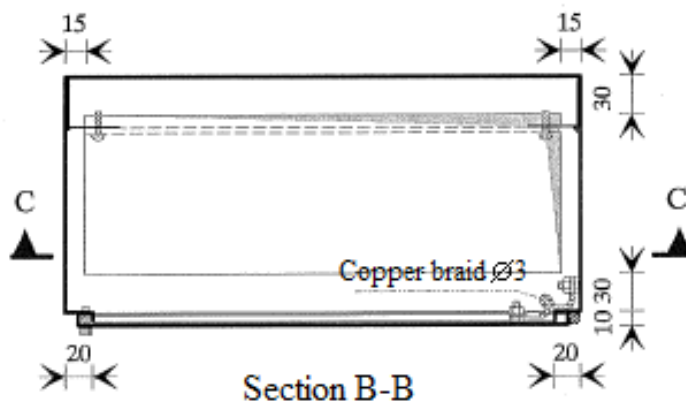

Section B-B

# Type CTI 252

Apparatus  
(dimensions in mm)

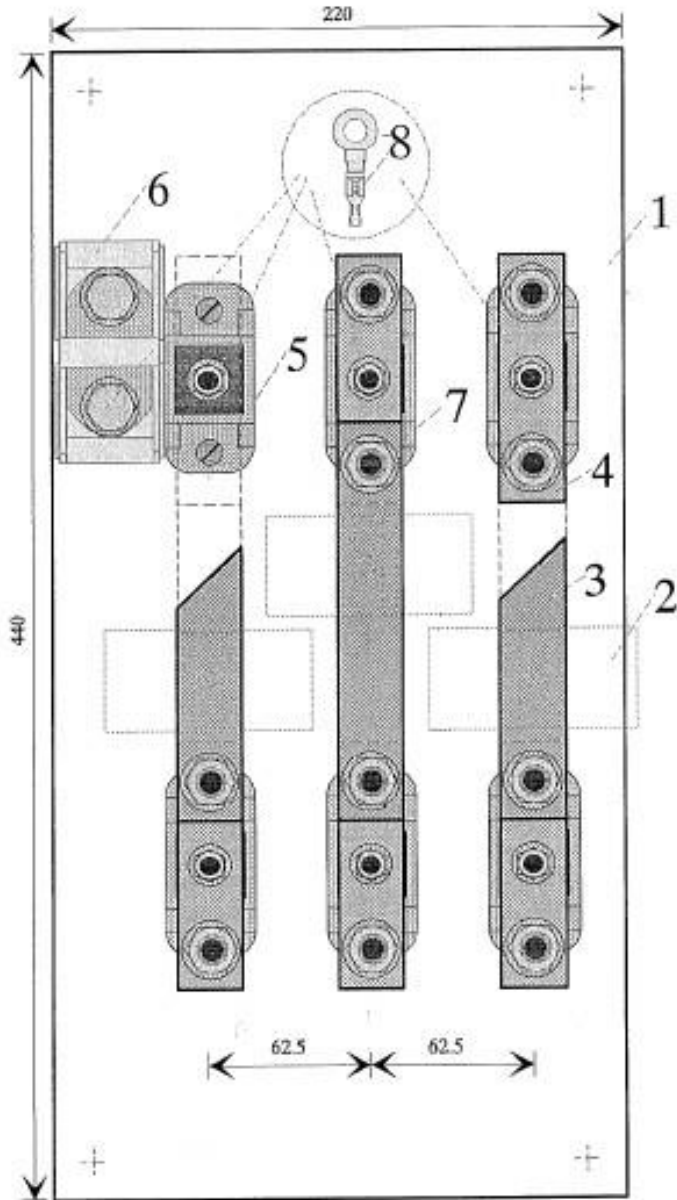



Type CTI 252

Characteristics

Quant.	Pos.	Designation	Characteristics	Observation
1	1	Installation plate	5 mm thickness bakelite	
3	2	Current transformer	100/5 A 150/5 A 200/5 A	NCEM C42-301 (provided by CEM)
3	3	Primary busbar of CT	Cu 25x5	Tinned
3	4	Connection busbar of CT	Cu 25x5	Tinned
3	5	Low voltage Insulator	Porcelain Insulator	"MEM – 10BM"
1	6	Neutral connection terminal	Isolated terminal	"IZUMI – BA811S"
12	7	Hexagonal headed screw M10x30 Hexagonal nut Two washers Spring washer	Mild steel Mild steel Mild steel Steel	Zinc and passivated
4	8	Connection terminal	Copper	For connection of conductors of voltage meter

# Type CTI 252

Installation plate  
(dimensions in mm)

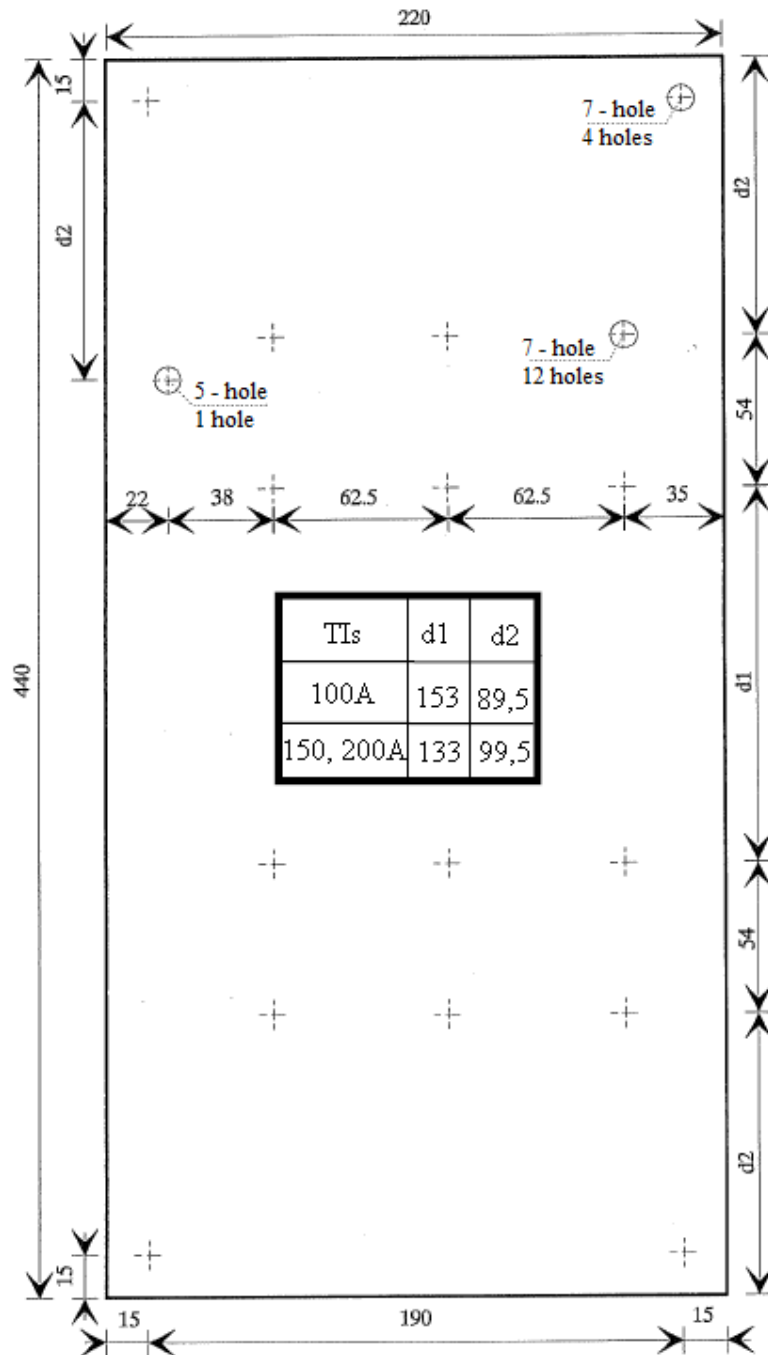

Type CTI 252

Detail  
(dimensions in mm)

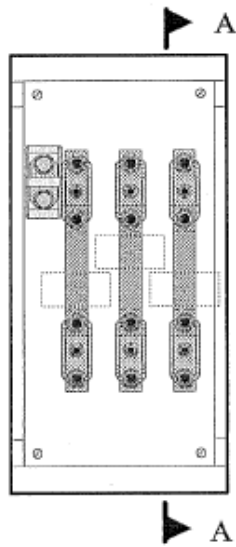
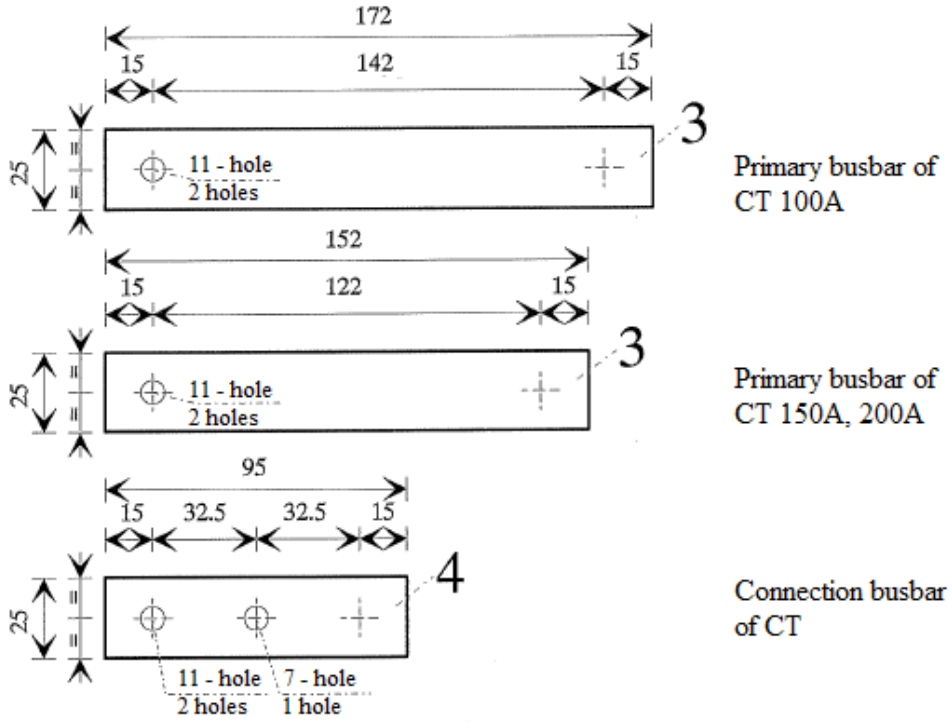

Interior View

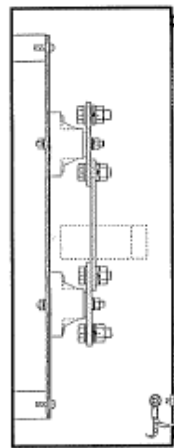

Section A-A

# Type CTI 302

Apparatus  
(dimensions in mm)

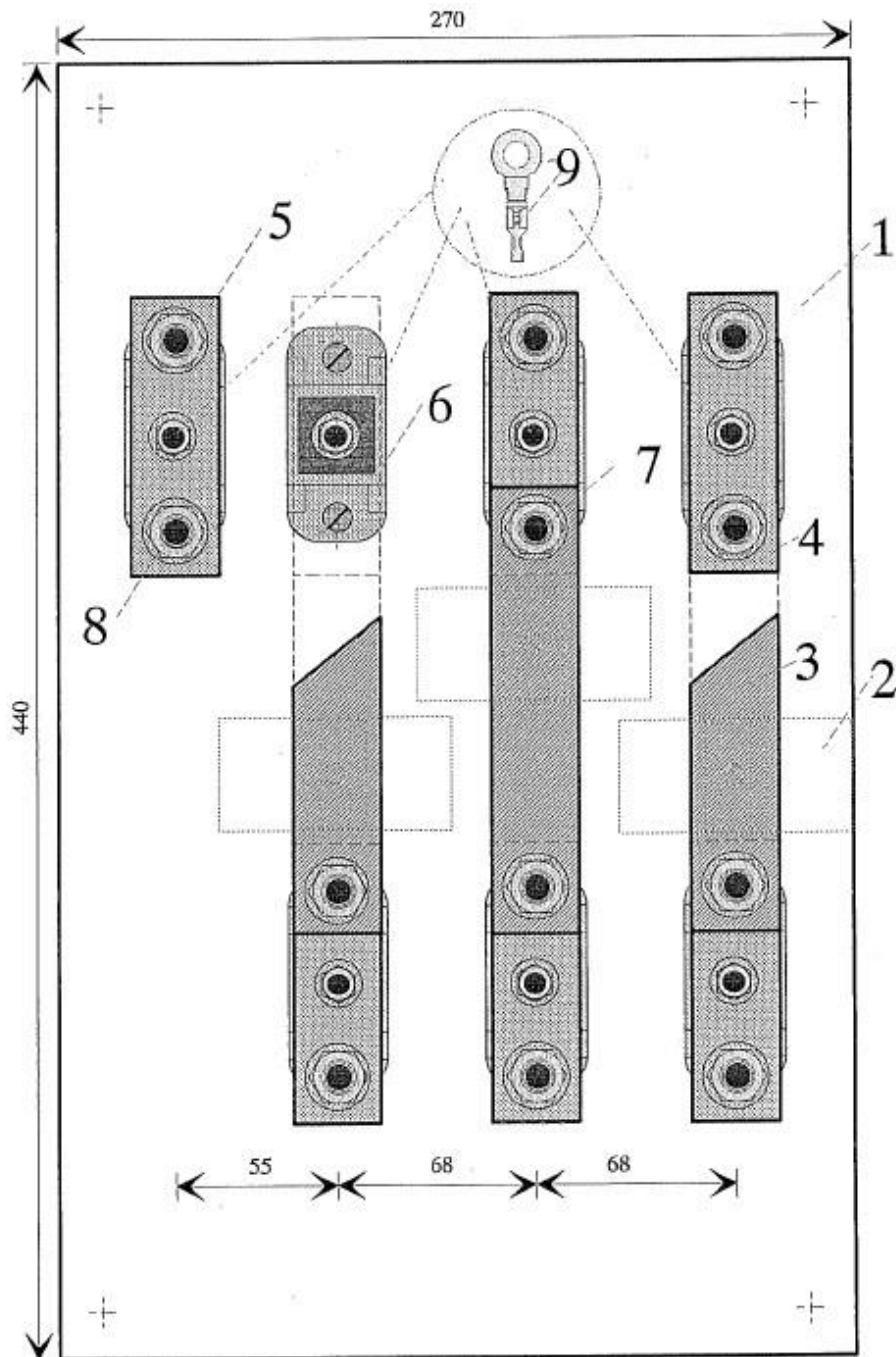

Type CTI 302

Characteristics

Quant.	Pos.	Designation	Characteristics	Observation
1	1	Installation plate	5 mm thickness	
3	2	Current transformer	300/5 A 400/5 A	NCEM C42-301 (provided by
3	3	Primary busbar of CT	Cu 30x10	Tinned
3	4	Connection busbar of CT	Cu 30x10	Tinned
1	5	Neutral connection busbar	Cu 30x5	Tinned
4	6	Low voltage Insulator	Porcelain Insulator	"MEM – 10BM"
12	7	Hexagonal headed screw M10x40 Hexagonal nut Two washers Spring washer	Mild steel Mild steel Mild steel Steel	Zinc and passivated
2	8	Hexagonal headed screw M10x30 Hexagonal nut Two washers Spring washer	Mild steel Mild steel Mild steel Steel	Zinc and passivated
4	9	Connection terminal	Copper	For connection of conductors of

Type CTI 302

Installation plate  
(dimensions in mm)

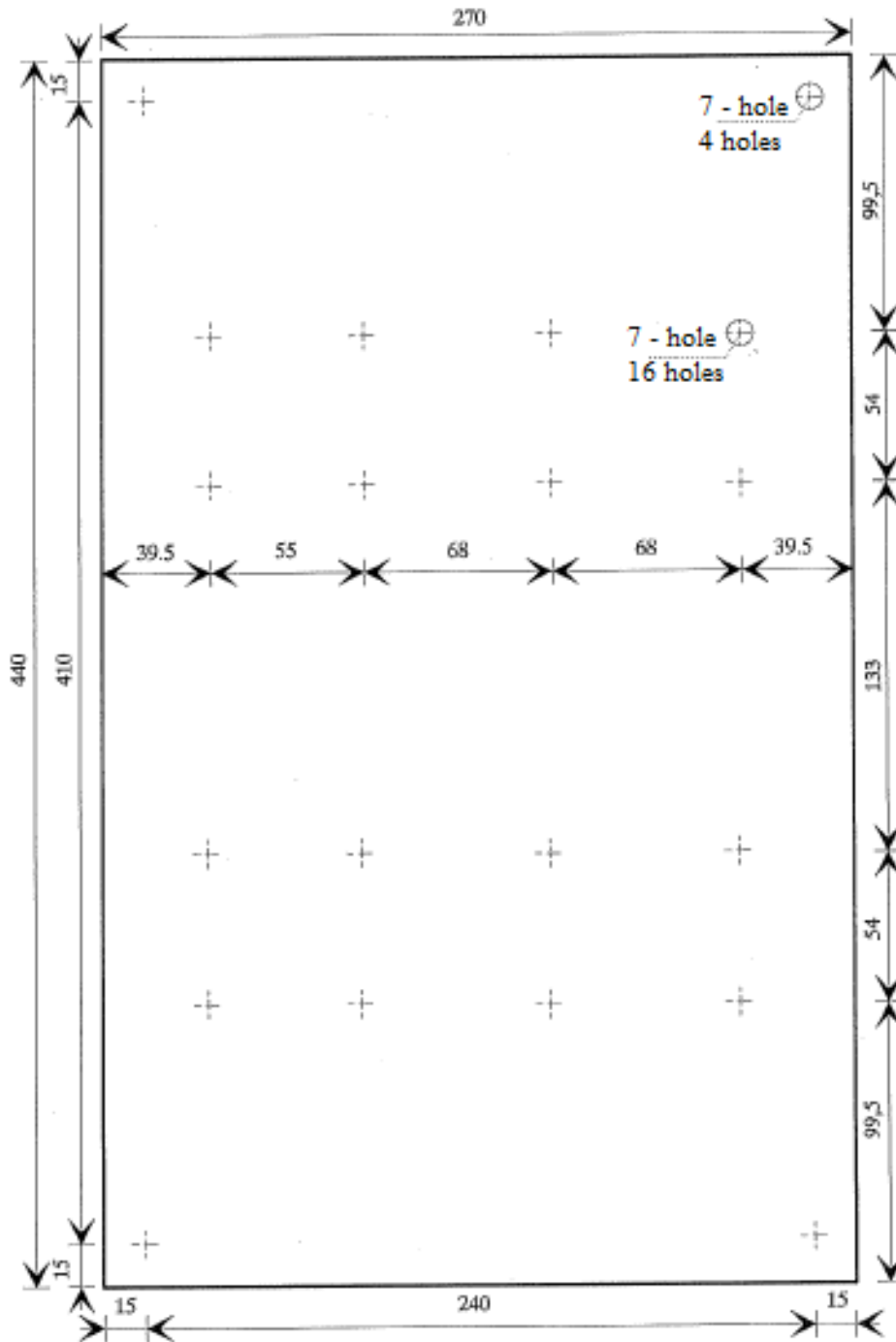

Type CTI 302

Detail  
(dimensions in mm)

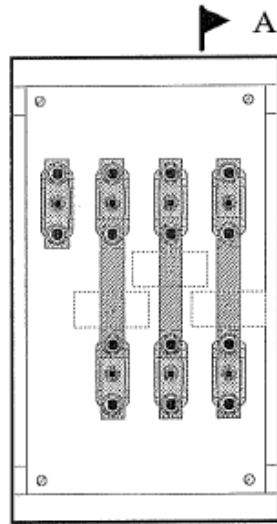
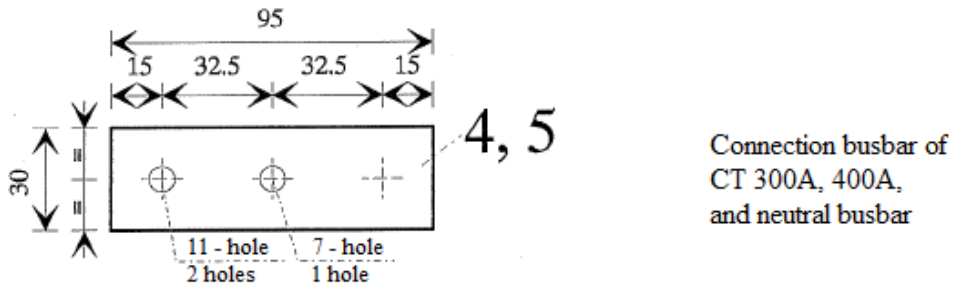
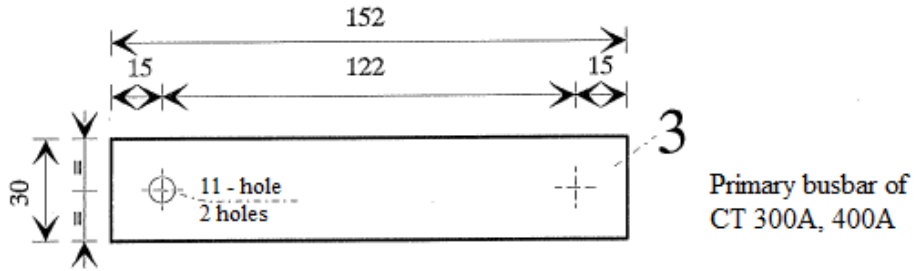

Interior View

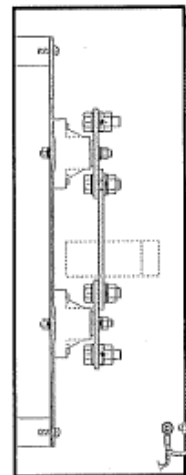

Section A-A

# Type CTI 352

Apparatus  
(dimensions in mm)

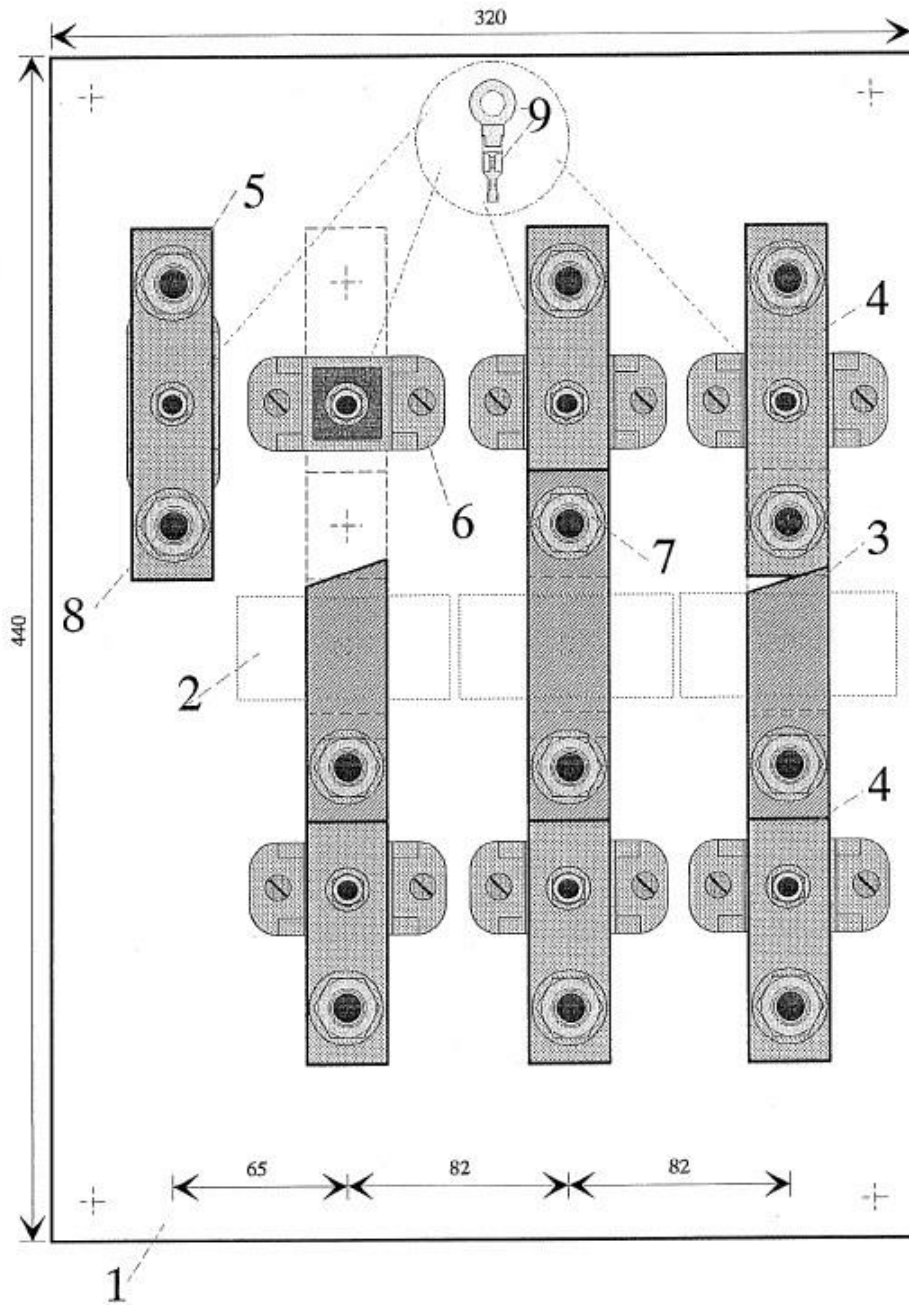



Type CTI 352

Characteristics

Quant.	Pos.	Designation	Characteristics	Observation
1	1	Installation plate	5 mm thickness	
3	2	Current transformer	500/5 A 600/5 A	NCEM C42-301 (provided by
3	3	Primary busbar of CT	■ Cu 30x10	Tinned
3	4	Connection busbar of CT	■ Cu 30x10	Tinned
1	5	Neutral connection busbar	■ Cu 30x5	Tinned
4	6	Low voltage insulator	Porcelain insulator	"MEM – 10BM"
12	7	Hexagonal headed screw M12x45 Hexagonal nut Two washers Spring washer	Mild steel Mild steel Mild steel Steel	Zinc and passivated
2	8	Hexagonal headed screw M12x35 Hexagonal nut Two washers Spring washer	Mild steel Mild steel Mild steel Steel	Zinc and passivated
4	9	Connection terminal	Copper	For connection of conductors of

Type CTI 352

Installation plate  
(dimensions in mm)

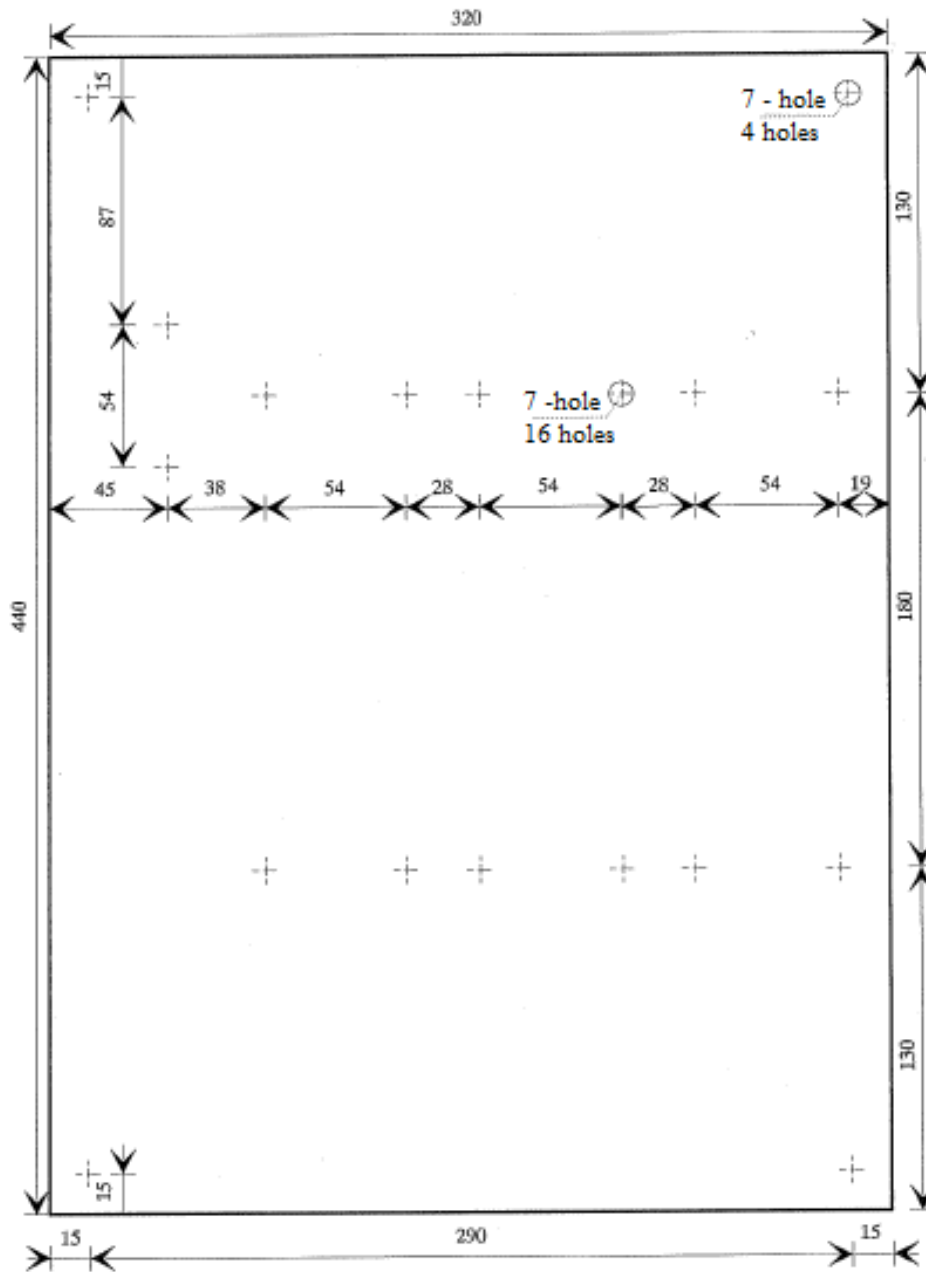

Type CTI 352

Detail  
(dimensions in mm)

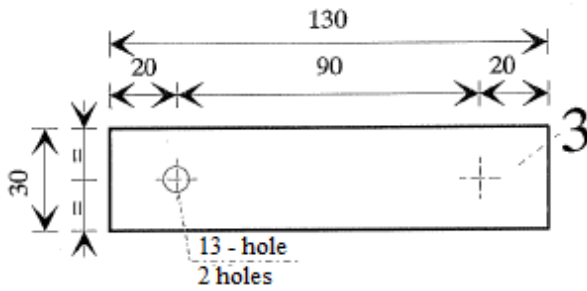

Primary busbar of  
CT 500A, 600A

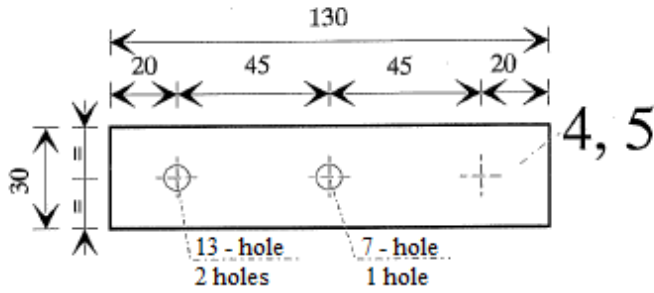

Connectin busbar of  
CT 500A, 600A,  
and neutral busbar

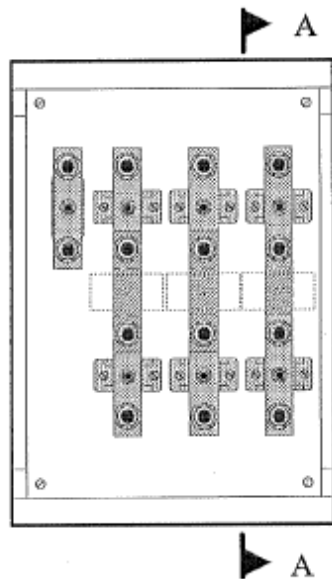

Interior View

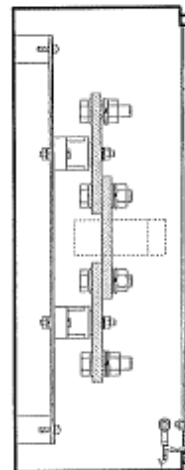

Section A-A

# Installation examples

Type CTI 251/2 ,  $I \leq 200$   
(dimensions in mm)

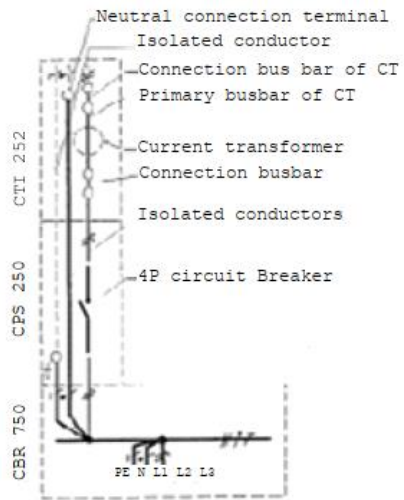
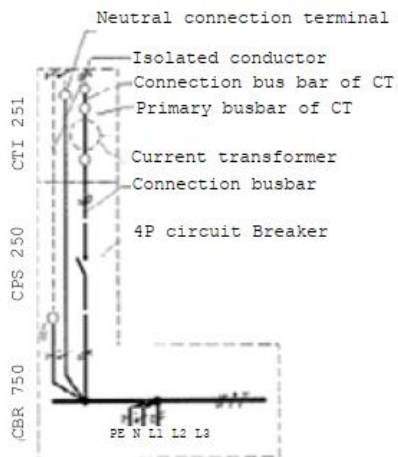
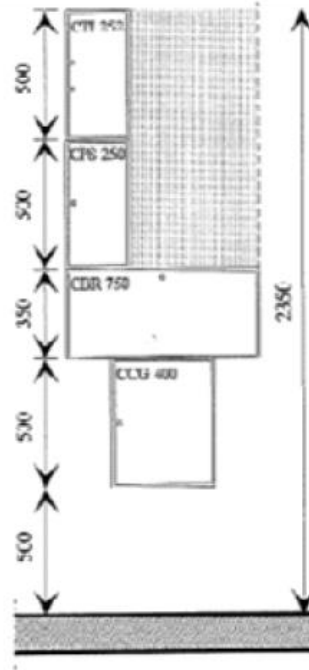
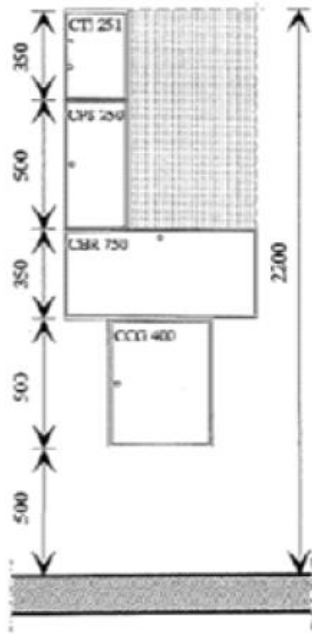

Type CTI 301/2 · I<sub>≤</sub>400A

(dimensions in mm)

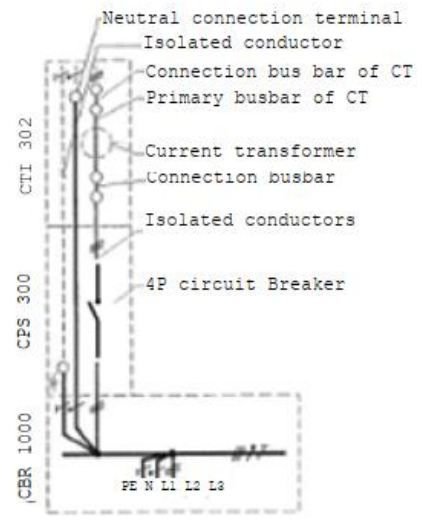
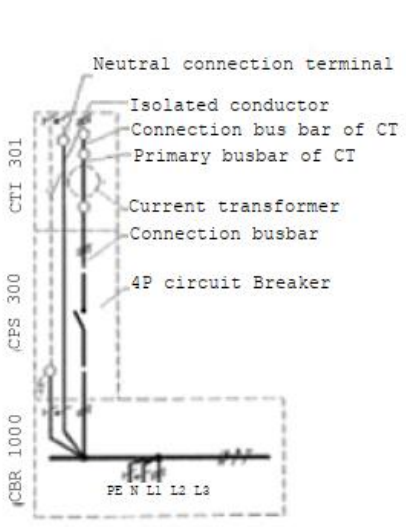
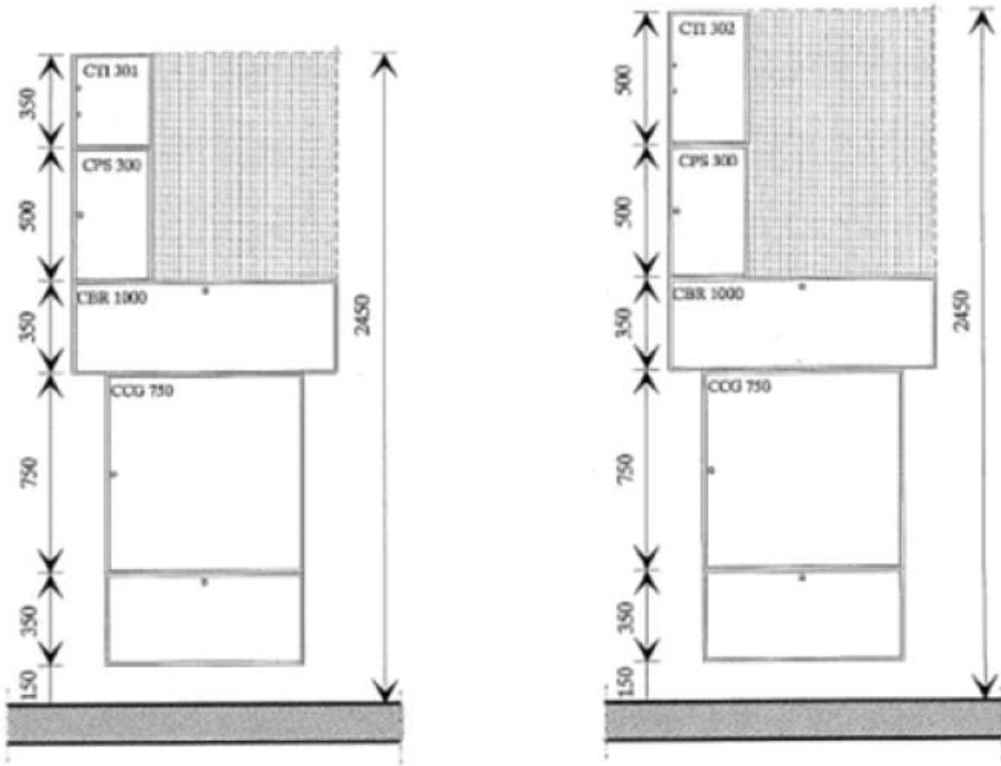

Type CTI 351/2,  $I \leq 600A$   
 (dimensions in mm)

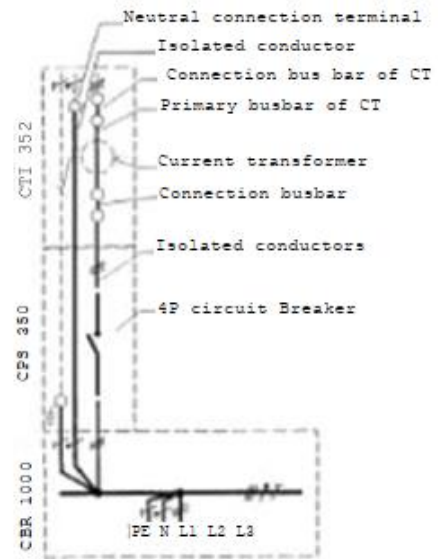
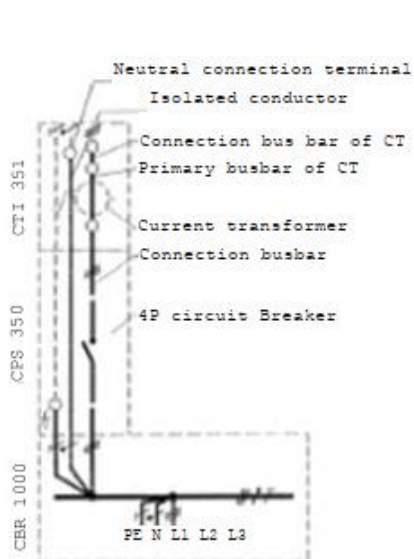
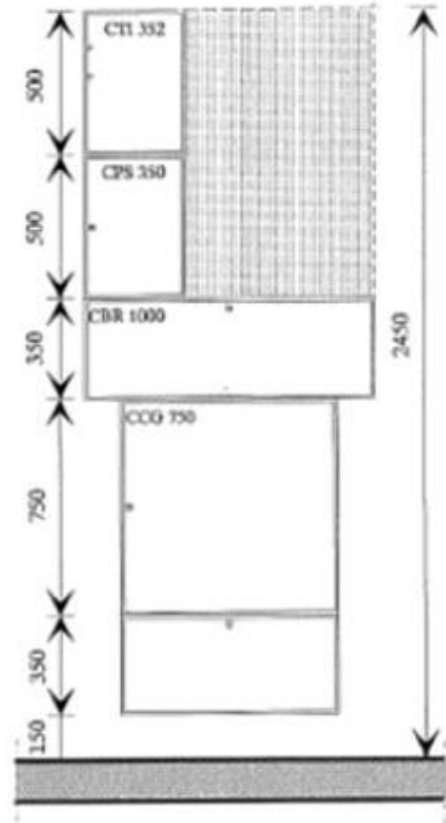
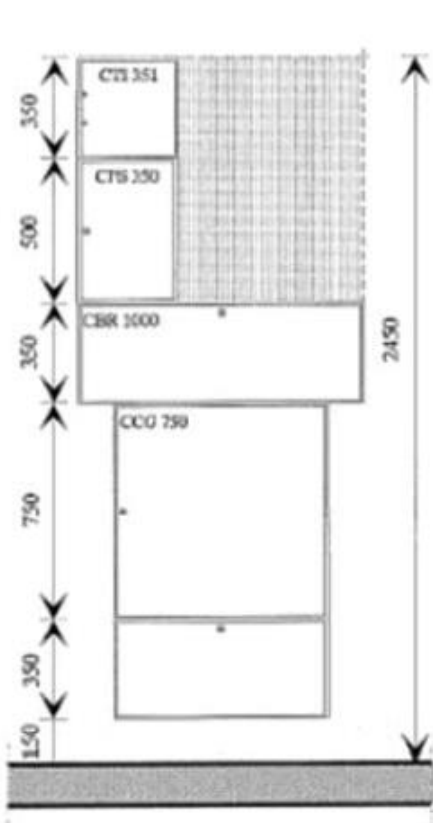



# **TECHNICAL SPECIFICATION**

**NCEM C62-316**

**June 2022**

**Compartment for Current  
Transformer**

## Contents

1. Application field .....	3
2. Rated values .....	3
3. Constructive features .....	3
3.1 Generalities .....	3
3.2 Types of compartments .....	3
3.3 Constitution .....	4
3.4 Enclosure .....	4
Compartments for current transformer .....	6
Apparatus for Type CPTI 22 .....	10
Apparatus for Type CPTI 62 .....	15
Apparatus for Type CPTI 80 .....	20
Apparatus for Type CPTI 100 .....	23
Apparatus for Type CPTI 150 .....	26
Apparatus for Type CPTI 200 .....	29
Apparatus for Type CPTI 250 .....	32



## 1. Application field

This specification sets requirements for the indoor metallic switchboards with compartments for the installation of current transformers used for energy metering where electricity is supplied in low voltage by CEM.

These compartments are referred to briefly as "CPTI".

## 2. Rated values

- Rated voltage: 1 kV
- Number of phases: 3

The rated currents are:

200 A, 600 A, 800 A, 1000 A, 1500 A, 2000 A, 2500 A,  
corresponding to the maximum rated currents of current transformers, which can be installed.

## 3. Constructive features

### 3.1 Generalities

The compartments shall be designed and constructed in such a way as to ensure, in normal use, the correct operation of the equipment installed therein and the necessary safety conditions.

### 3.2 Types of compartments

For the purpose of this section, the following types of compartments are considered:

- Type CPTI 22 – Compartment for current transformers,  $I_n \leq 200A$ , in which the connector is in insulated cables;
- Type CPTI 62 – Compartment for current transformers,  $I_n \leq 600A$ , in which the connector is in insulated conductors or cables;
- Type CPTI 80 – Compartment for current transformers,  $I_n = 800A$ , in which the connector is in copper bar;
- Type CPTI 100 – Compartment for current transformers,  $I_n = 1000A$ , in which the connector is in copper bar;
- Type CPTI 150 – Compartment for current transformers,  $I_n = 1500A$ , in which the connector is in copper bar;
- Type CPTI 200 – Compartment for current transformers,  $I_n = 2000A$ , in

- which the connector is in copper bar;
- Type CPTI 250 – Compartment for current transformers,  $I_n=2500A$ , in which the connector is in copper bar;

Type of Compartment	Enclosure		
	Width	Height	Depth
CPTI 22	350	400	190
CPTI 62	350	500	190
CPTI 80	400	350	190
CPTI 100	500	350	190
CPTI 150	450	350	230
CPTI 200	500	350	230
CPTI 250	500	400	230

The compartments shall comply with the attached figures, considering that the indicated dimensions are understood as minimum.

The door, hinges and sealing system shall be of the type indicated in the attached figures.

### 3.3 Constitution

The compartments are made up of two distinct parts:

- a) Enclosure, intended to ensure protection of the equipment installed therein;
- b) Apparatus, necessary for the installation of the current transformers.

### 3.4 Enclosure

- Materials

The enclosure of the compartments shall be constructed of galvanized sheet steel with a minimum 1.5 mm thickness and a plating thickness of not less than 20  $\mu\text{m}$ .

- Protection against corrosion

The enclosure should be protected against corrosion by observing the following:

- A zinc-rich primer coating (zinc powder or zinc chromate), a wash-primer coating and a finish enamel coating should be applied successively to the carefully cleaned and degreased sheet. A coating of finish marine type enamel shall be applied (Transocean Marine Paint, Hammer-Tone finish, color 916-05, or equivalent type from another manufacturer, but of similar color).

The hinges, screws, nuts and washers should preferably be of stainless material or be effectively protected against corrosion by galvanizing and passivation.

- Opening for passage of electrical conduits

The opening for passage of electrical conduits should be painted, immediately after its execution, with a coat of primer of the type used in the painting of the boxes.

The passage of the conduits will be carried out:

- a) For tube, nozzles or stoppers are used with suitable cross-section of the tube, and are in thermoplastic material;
  - b) For multicore cable, glands of adequate diameter are used;
  - c) For single core cable, glands of suitable diameter are used and applied on a bakelite plate, fixed by an appropriate device to the compartments;
  - d) For copper bar, a bakelite plate is used as busbar support, fixed a device appropriate to the respective CPS.
- Apparatus

The apparatus required the installation of current transformers should be as shown in the attached figures.

- Electrical equipment

The compartments are intended to contain the measurement transformers to be supplied by CEM, namely the low voltage current transformers to be used with electric energy meters.

Compartments for current transformer

Enclosure

Compartment without installation plate  
(dimensions in mm)

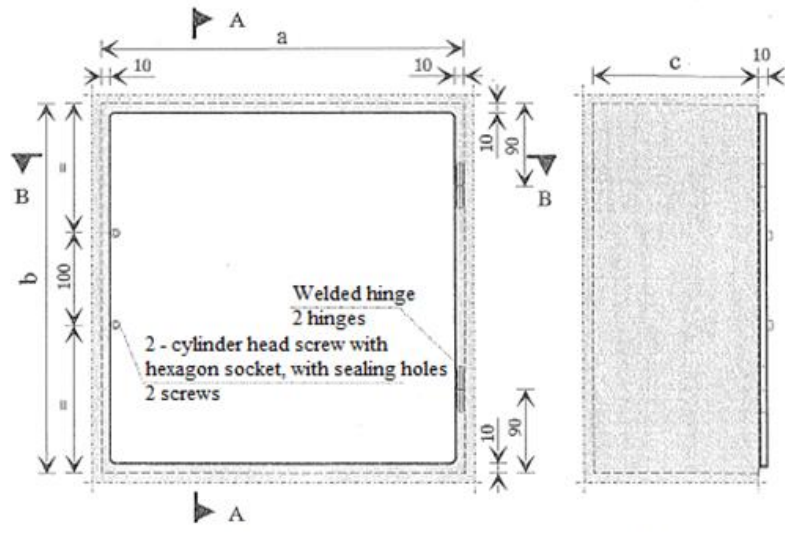

Front View

Side View

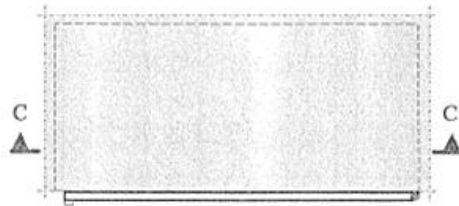

Top View

	a	b	c
CPTI 80	400	350	180
CPTI 100	500	350	180
CPTI 150	450	350	220
CPTI 200	500	350	220
CPTI 250	500	400	220

# Enclosure

Compartment without installation plate  
(dimensions in mm)

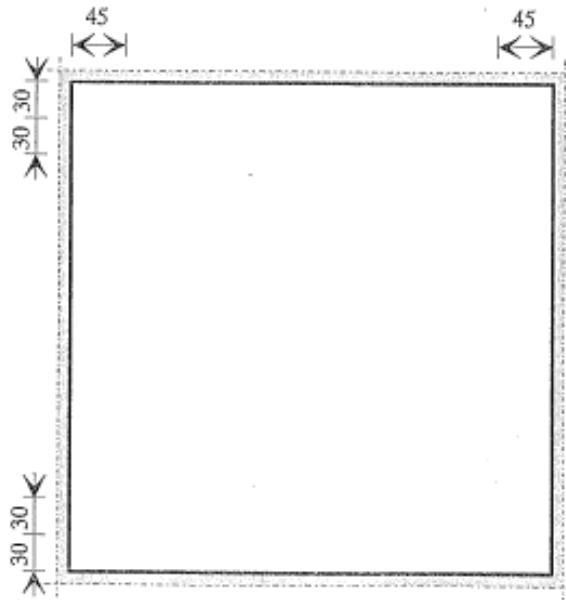

Section C-C

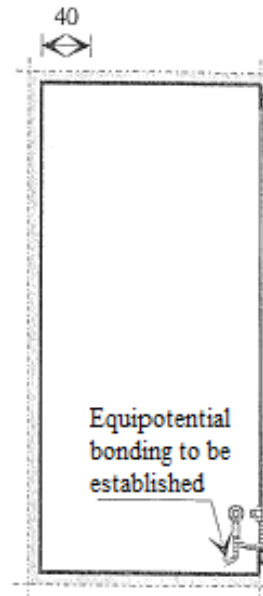

Section A-A

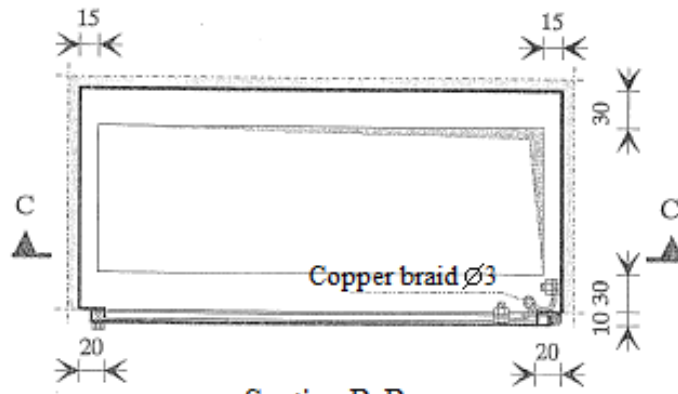

Section B-B

## Enclosure

Compartment with installation plate  
(dimensions in mm)

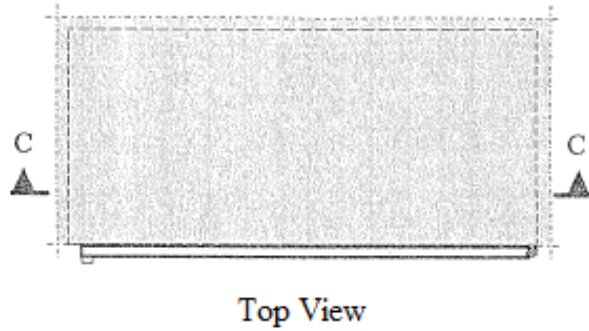
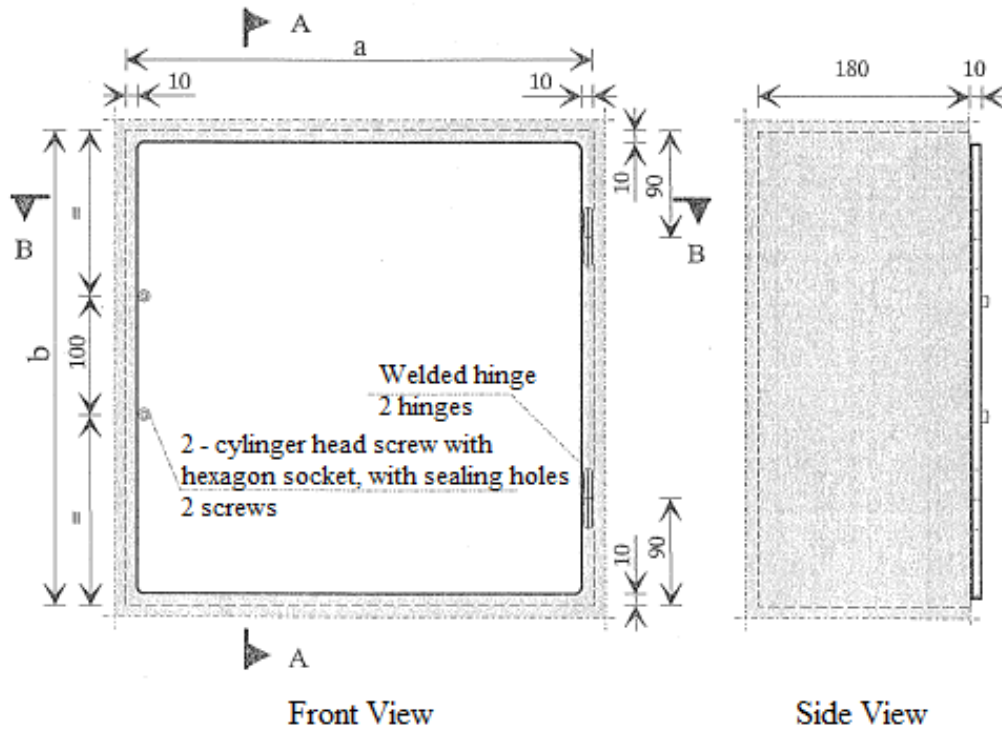

	a	b
CPTI 22	350	400
CPTI 62	350	500

# Enclosure

Compartment with installation plate  
(dimensions in mm)

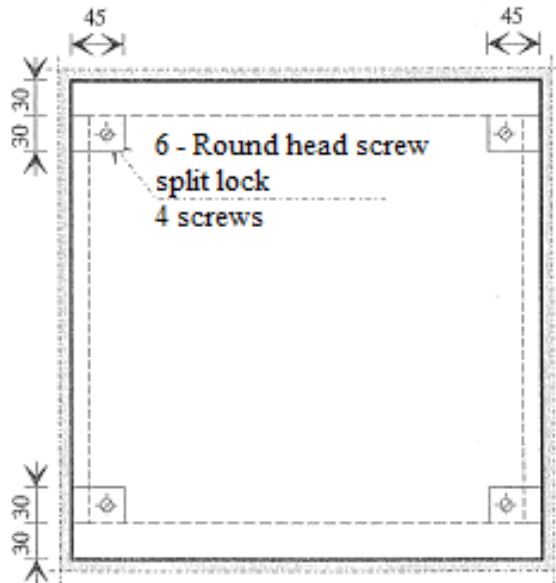

Section C-C

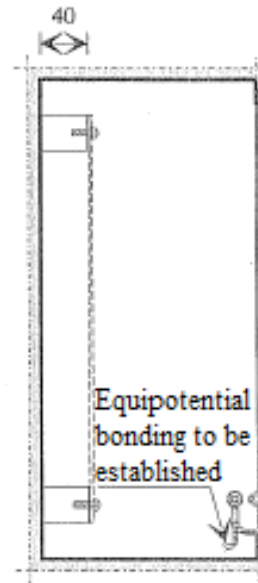

Section A-A

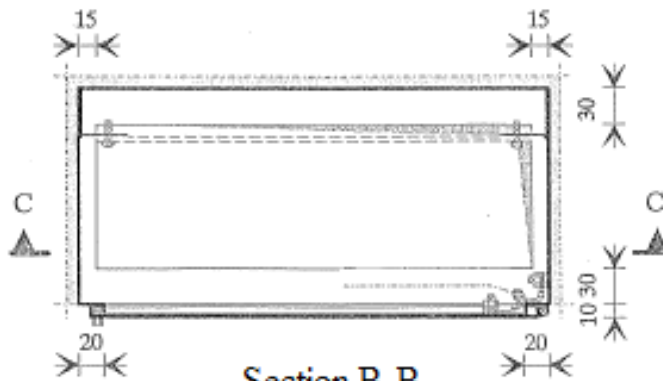

Section B-B

# Apparatus for Type CPTI 22

Presentation  
(dimensions in mm)

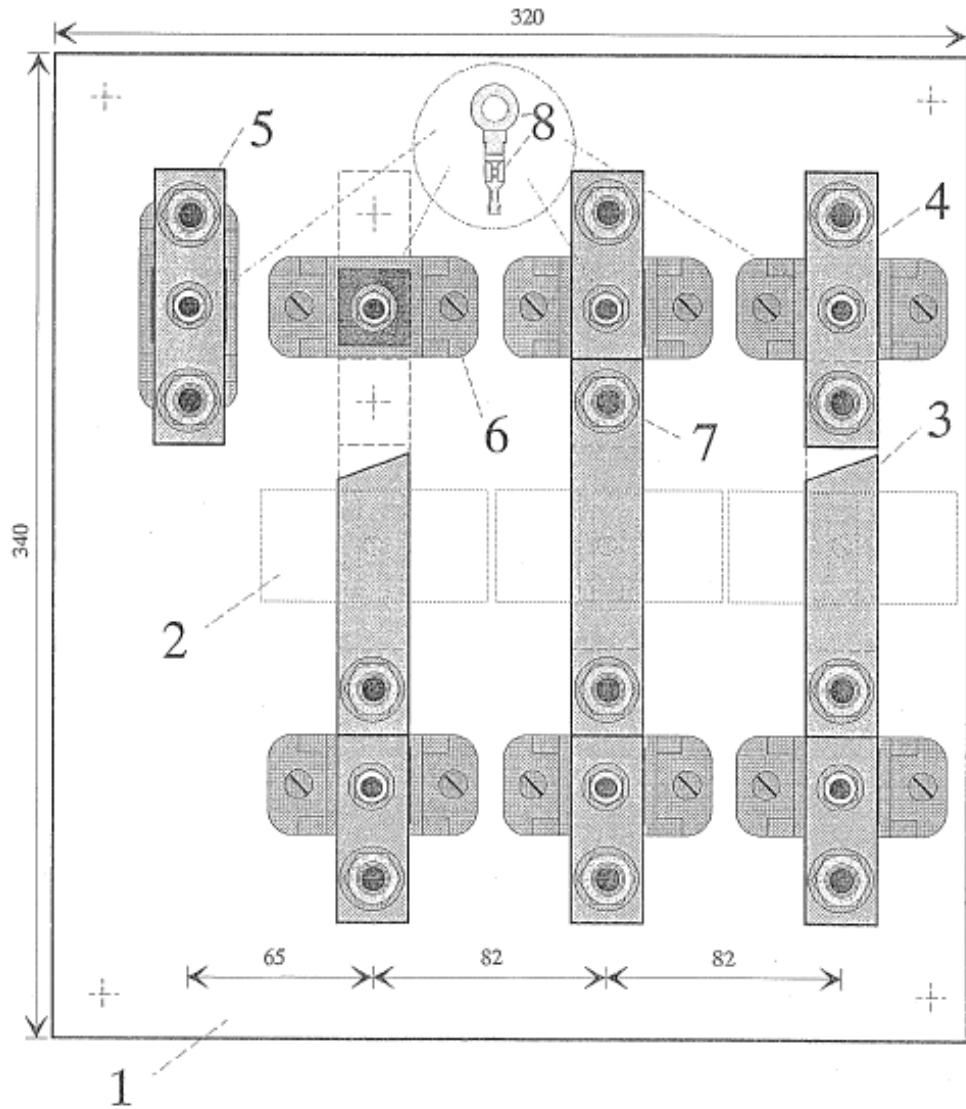



## Apparatus for Type CPTI 22

### Characteristics

Quant.	Pos.	Designation	Characteristics	Observation
1	1	Installation plate	5 mm thickness bakelite	
3	2	Current transformer	100/5 A 150/5 A 200/5 A	NCEMC42-301 (provided by CEM)
3	3	Primary busbar of CT	■ Cu25x5	Tinned
6	4	Connection busbar of CT	■ Cu25x5	Tinned
1	5	Connection busbar of neutral conductor	■ Cu25x5	Tinned
7	6	Low voltage insulator	Porcelain insulator "MEM – 10BM"	
14	7	Hexagonal headed screw M10x35 Hexagonal nut Two washers Spring washer	Mild steel Mild steel Mild steel Steel	Galvanized
4	8	Connection terminal	Copper	For connection of conductors of voltage meter

# Apparatus for Type CPTI 22

Installation plate  
(dimensions in mm)

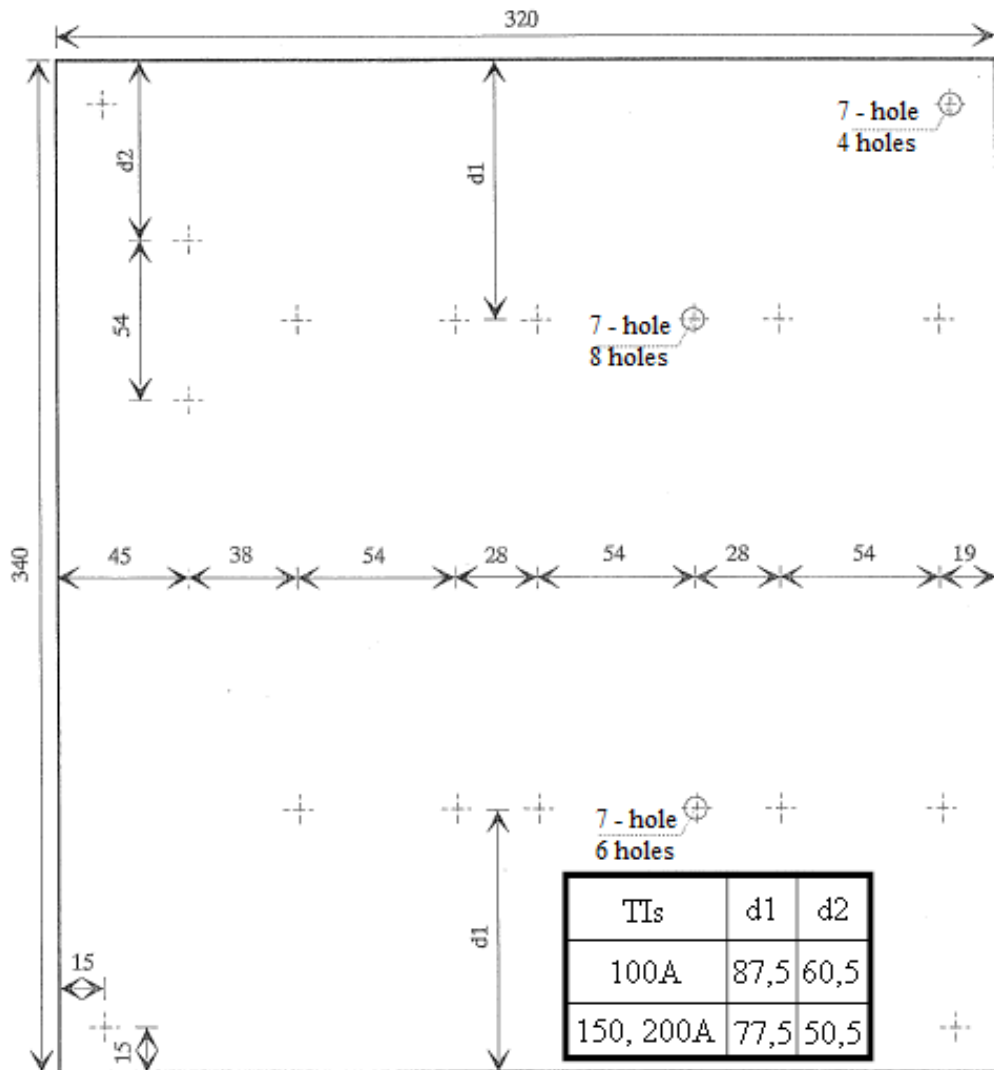

Apparatus for Type CPTI 22

Detail  
(dimensions in mm)

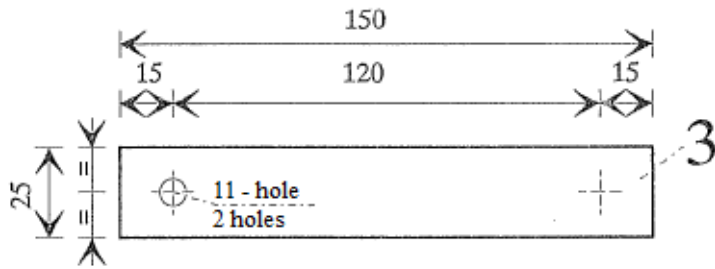

Primary busbar  
for CT 100A

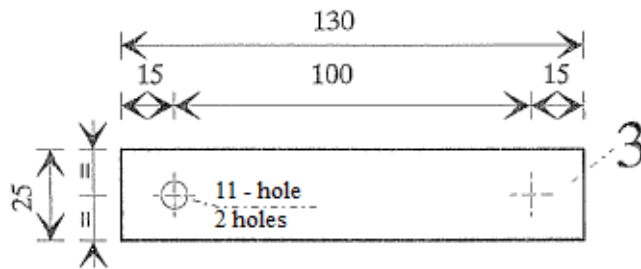

Primary busbar  
for CT 150A, 200A

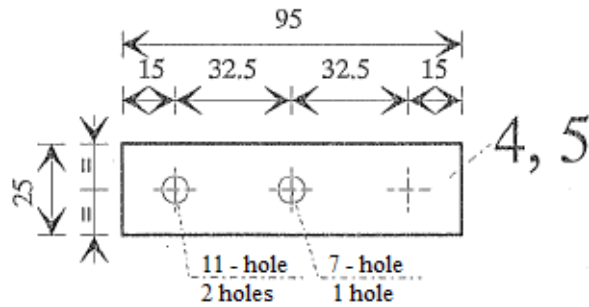

Connection busbar, for  
CT 100A, 150A, 200A

Connectin busbar of  
neutral conductor

Apparatus for Type CPTI 22

Detail  
(dimensions in mm)

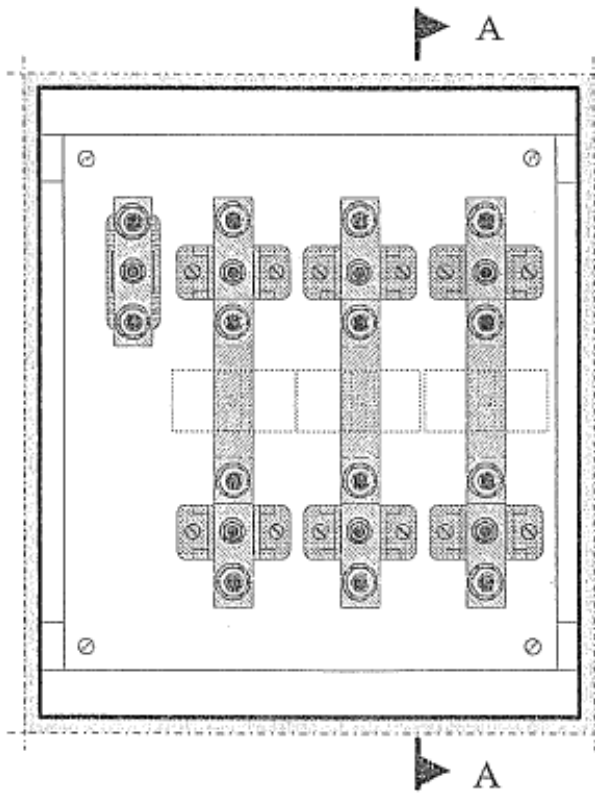

Interior View

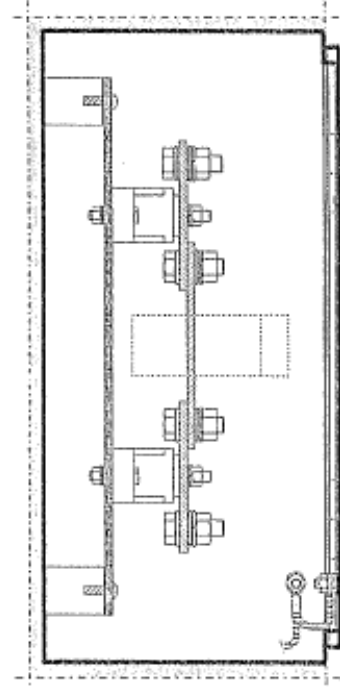

Section A-A

# Apparatus for Type CPTI 62

Presentation  
(dimensions in mm)

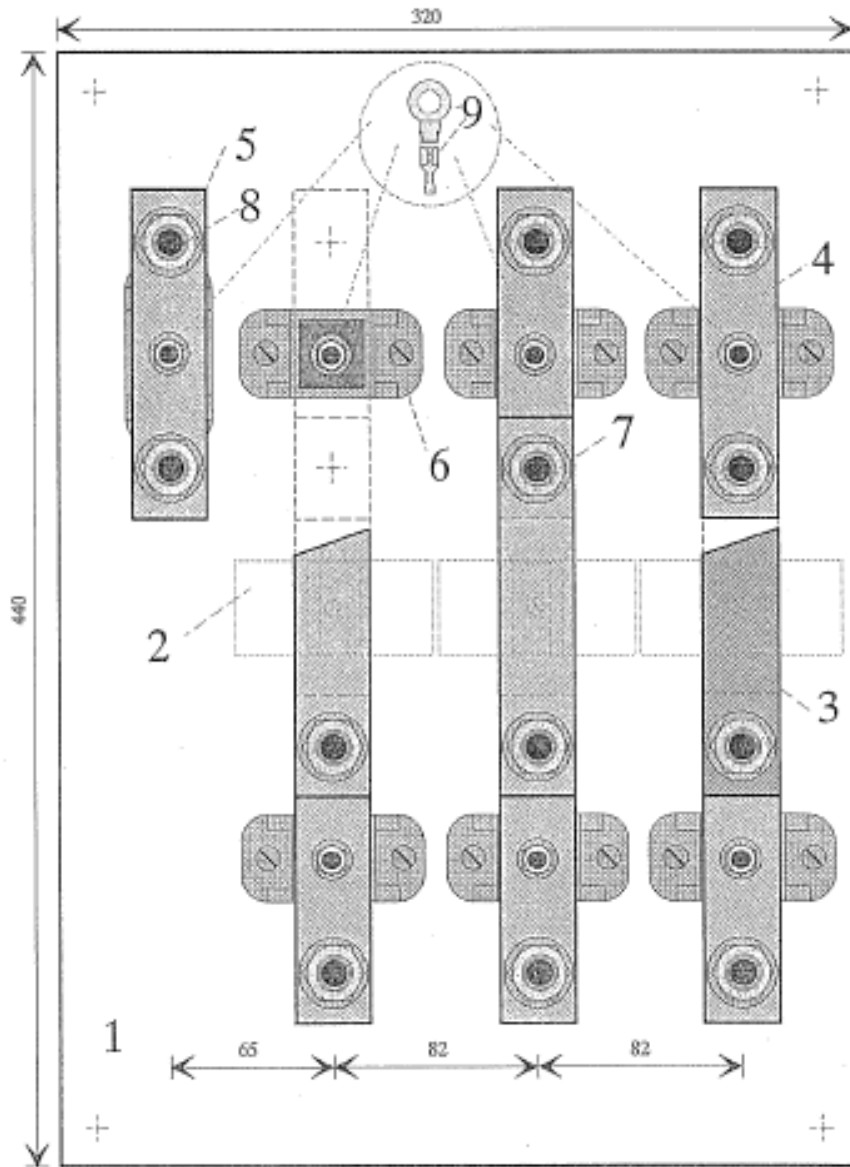

## Apparatus for Type CPTI 62

### Characteristics

Quant.	Pos.	Designation	Characteristics	Observation
1	1	Installation plate	5 mm thickness bakelite	
3	2	Current transformer	250/5 A 300/5 A 400/5 A 500/5 A 600/5 A	NCEMC42-301 (provided by CEM)
3	3	Primary busbar of CT	■ Cu 30x10	Tinned
6	4	Connection busbar of CT	■ Cu 30x10	Tinned
1	5	Connection busbar of neutral conductor	■ Cu 30x5	Tinned
7	6	Low voltage insulator	Porcelain insulator "MEM – 10BM"	
12	7	Hexagonal headed screw M12x50 Hexagonal nut Two washers Spring washer	Mild steel Mild steel Mild steel Steel	Galvanized
2	8	Hexagonal headed screw M12x40 Hexagonal nut Two washers Spring washer	Mild steel Mild steel Mild steel Steel	Galvanized
4	9	Connection terminal	Copper	For connection of conductors of voltage meter

Apparatus for Type CPTI 62

Installation plate  
(dimensions in mm)

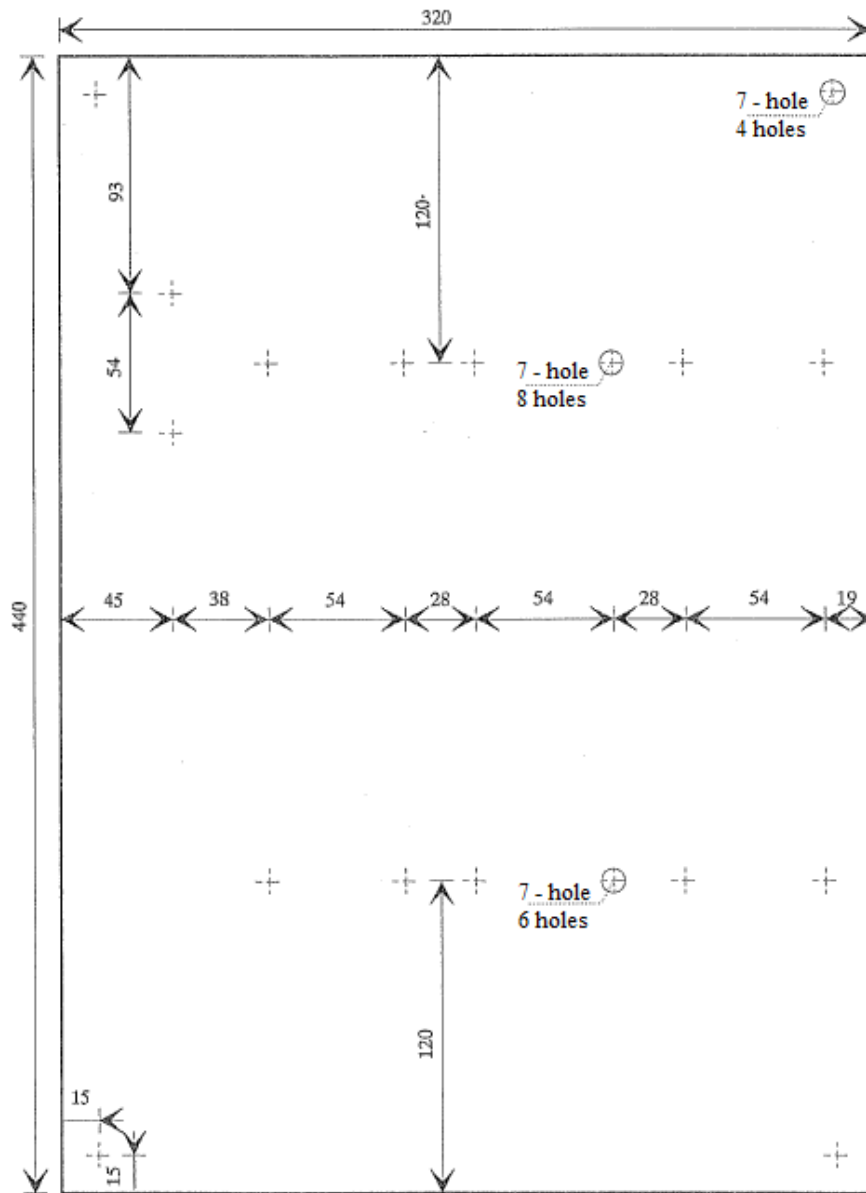

Apparatus for Type CPTI 62

Detail  
(dimensions in mm)

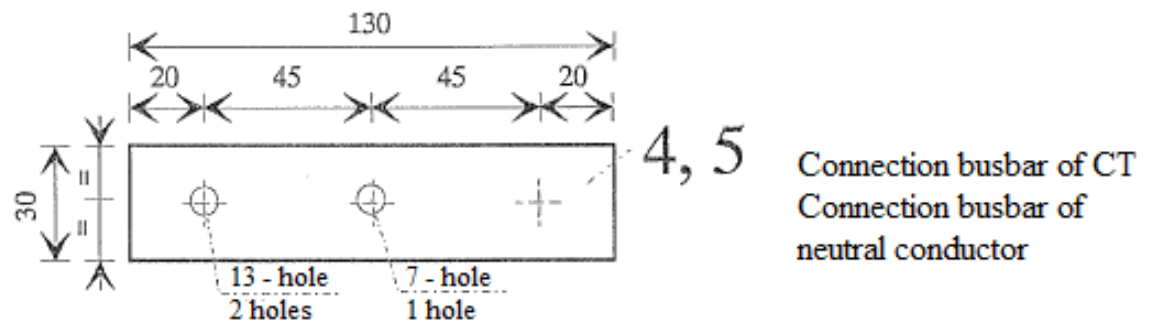
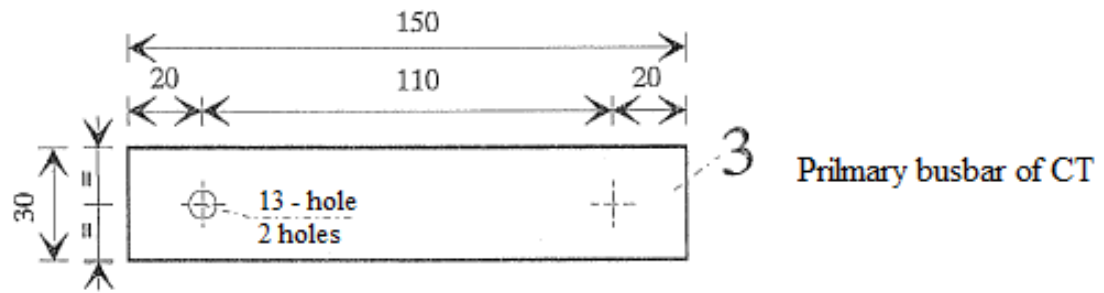



Apparatus for Type CPTI 62

Detail  
(dimensions in mm)

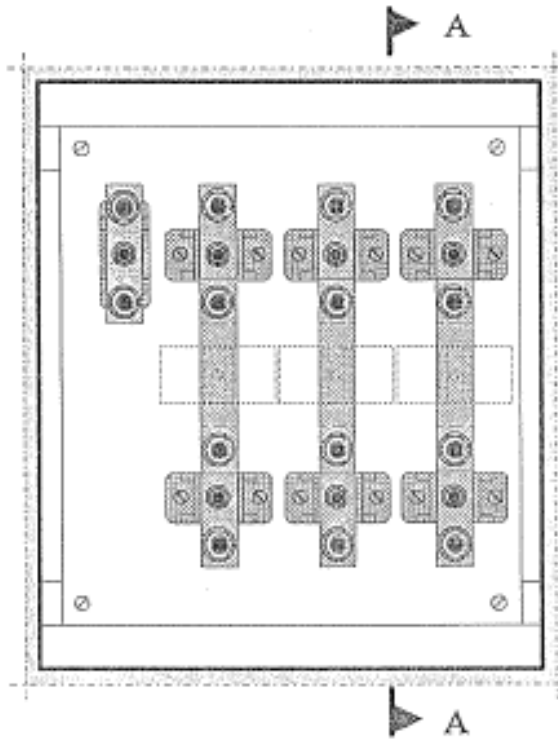

Interior View

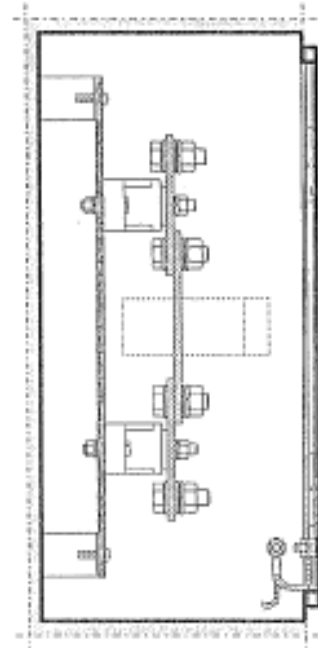

Section A-A

Apparatus for Type CPTI 80

Presentation  
(dimensions in mm)

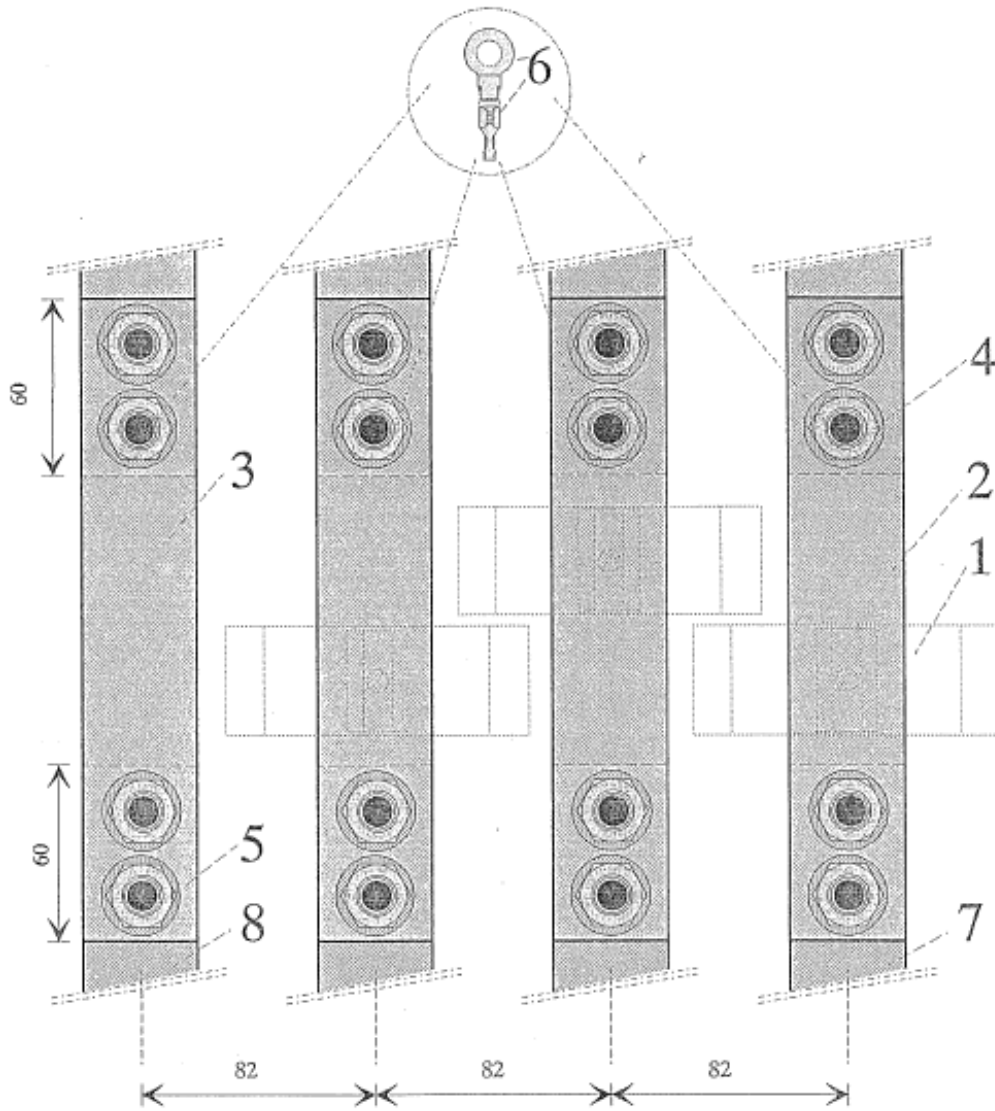

## Apparatus for Type CPTI 80

### Characteristics

Quant.	Pos.	Designation	Characteristics	Observation
3	1	Current transformer	800/5 A	NCEMC42-301 (provided by CEM)
3	2	Primary busbar of CT	■ Cu 40x10	Tinned
1	3	Neutral busbar	■ Cu 40x5	Tinned
6	4	Hexagonal headed screw M12x50 Hexagonal nut Two washers Spring washer	Mild steel Mild steel Mild steel Steel	Galvanized
2	5	Hexagonal headed screw M12x40 Hexagonal nut Two washers Spring washer	Mild steel Mild steel Mild steel Steel	Galvanized
4	6	Connection terminal	Copper	For connection of conductors of voltage meter
6	7	Connection busbar (phases)	■ Cu 40x10	Tinned
2	8	Connection busbar (neutral)	■ Cu 40x5	Tinned

Apparatus for Type CPTI 80

Detail  
(dimensions in mm)

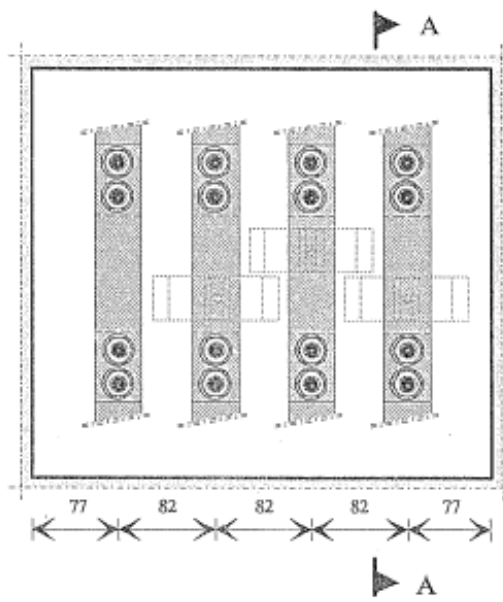
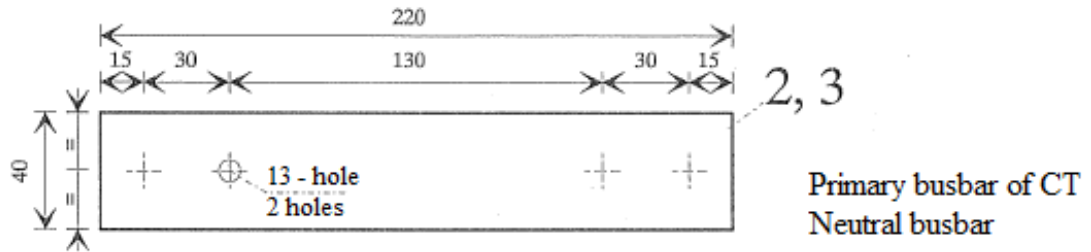

Interior View

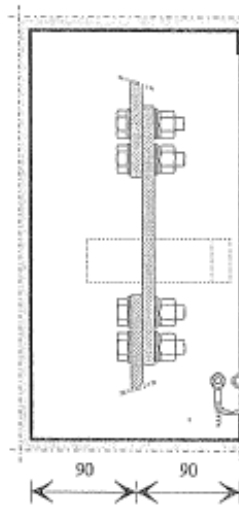

Section A-A

Apparatus for Type CPTI 100

Presentation  
(dimensions in mm)

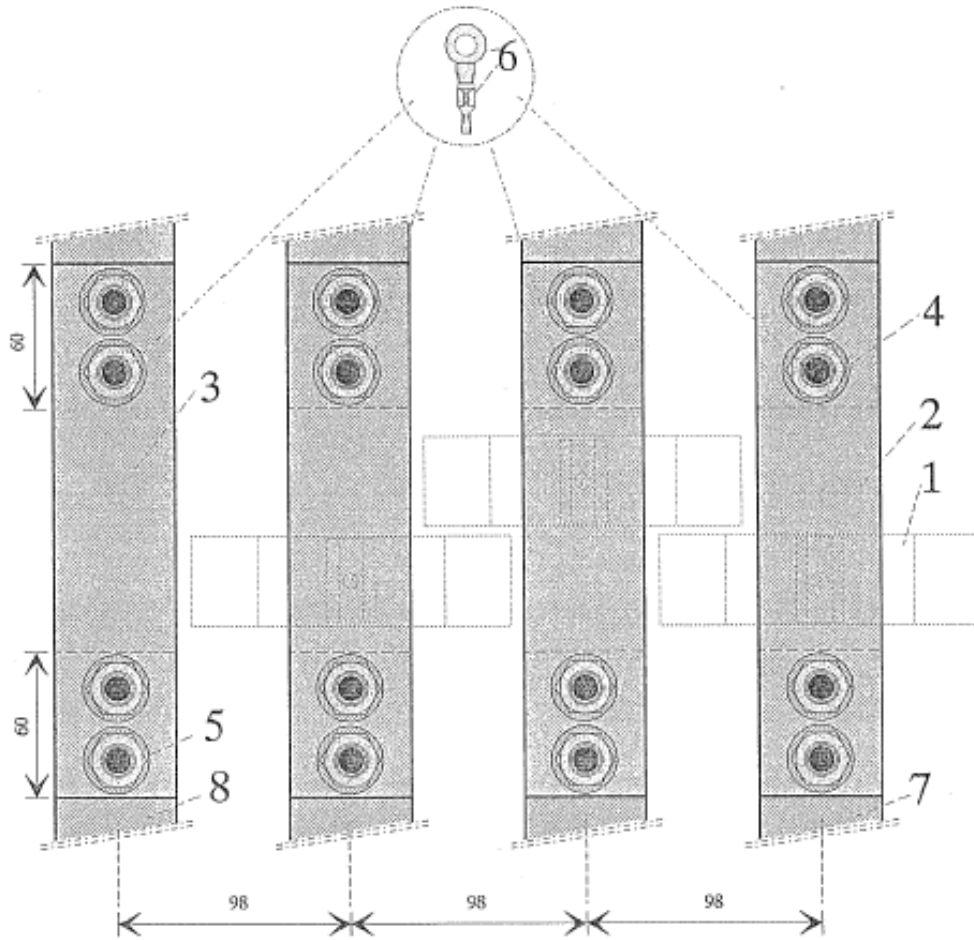

## Apparatus for Type CPTI 100

### Characteristics

Quant.	Pos.	Designation	Characteristics	Observation
3	1	Current transformer	1000/5 A	NCEMC42-301 (provided by CEM)
3	2	Primary busbar of CT	Cu50x10	Tinned
1	3	Neutral busbar	Cu50x5	Tinned
6	4	Hexagonal headed screw M12x50 Hexagonal nut Twowashers Springwasher	Mild steel Mild steel Mild steel Steel	Galvanized
2	5	Hexagonal headed screw M12x40 Hexagonal nut Twowashers Springwasher	Mild steel Mild steel Mild steel Steel	Galvanized
4	6	Connection terminal	Copper	For connection of conductors of voltage meter
6	7	Connection busbar (phases)	Cu50x10	Tinned
2	8	Connection busbar (neutral)	Cu50x5	Tinned

Apparatus for Type CPTI 100

Detail  
(dimensions in mm)

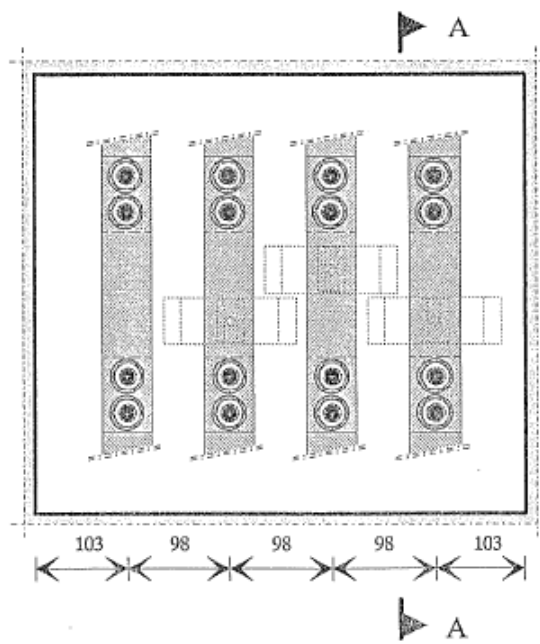
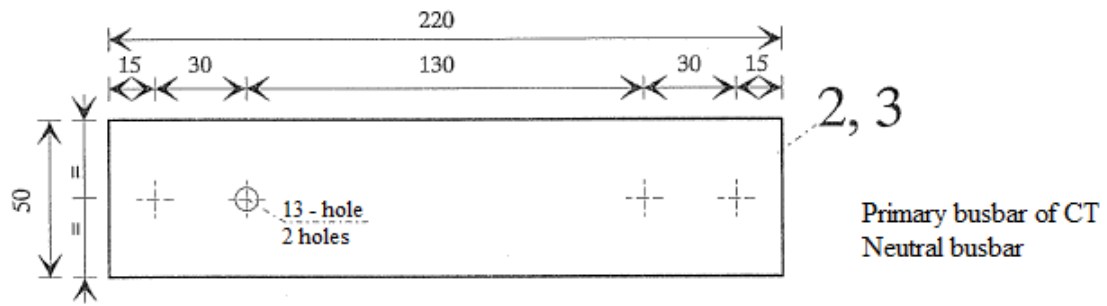

Interior View

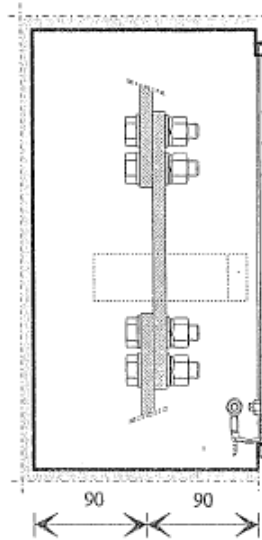

Section A-A

# Apparatus for Type CPTI 150

Presentation  
(dimensions in mm)

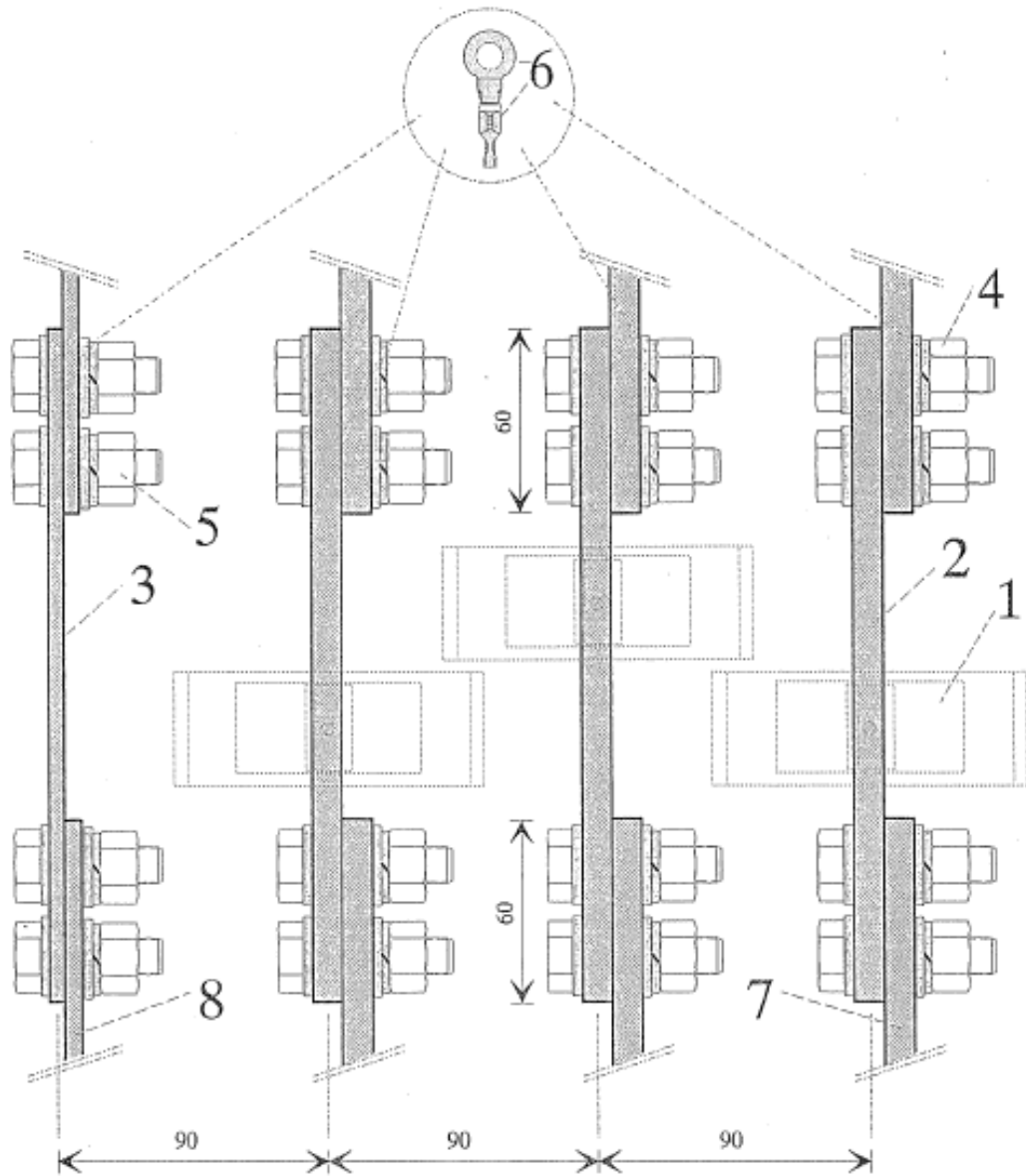



## Apparatus for Type CPTI 150

### Characteristics

Quant.	Pos.	Designation	Characteristics	Observation
3	1	Current transformer	1250/5 A 1500/5 A	NCEMC42-301 (provided by CEM)
3	2	Primary busbar of CT	Cu 80x10	Tinned
1	3	Neutral busbar	Cu 80x5	Tinned
24	4	Hexagonal headed screw M12x50 Hexagonal nut Two washers Spring washer	Mild steel Mild steel Mild steel Steel	Galvanized
8	5	Hexagonal headed screw M12x40 Hexagonal nut Two washers Spring washer	Mild steel Mild steel Mild steel Steel	Galvanized
4	6	Connection terminal	Copper	For connection of conductors of voltage meter
6	7	Connection busbar (phases)	Cu 80x10	Tinned
2	8	Connection busbar (neutral)	Cu 80x5	Tinned

# Apparatus for Type CPTI 150

Detail  
(dimensions in mm)

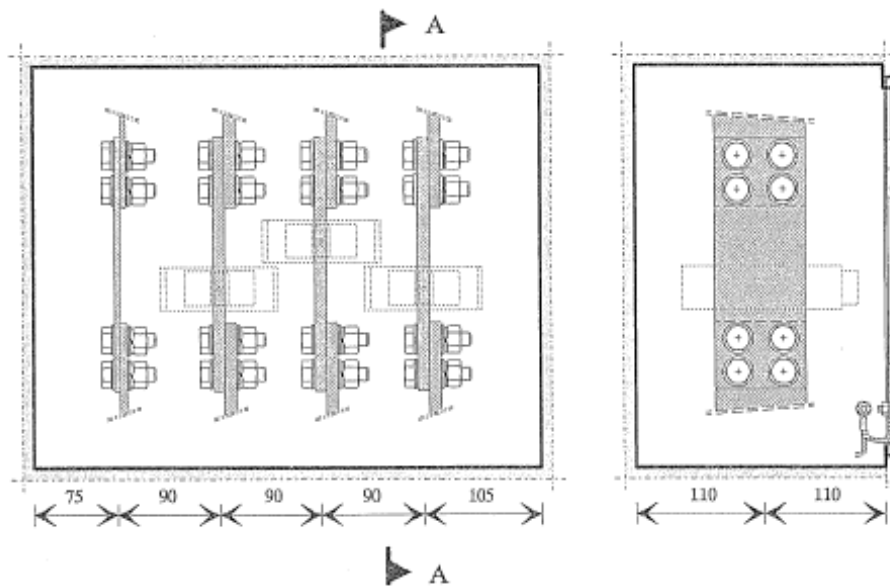
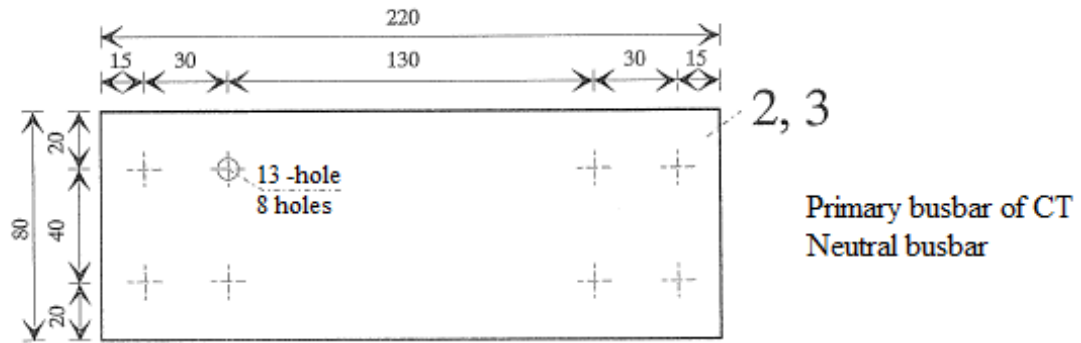

Interior View

Section A-A

Apparatus for Type CPTI 200

Presentation  
(dimensions in mm)

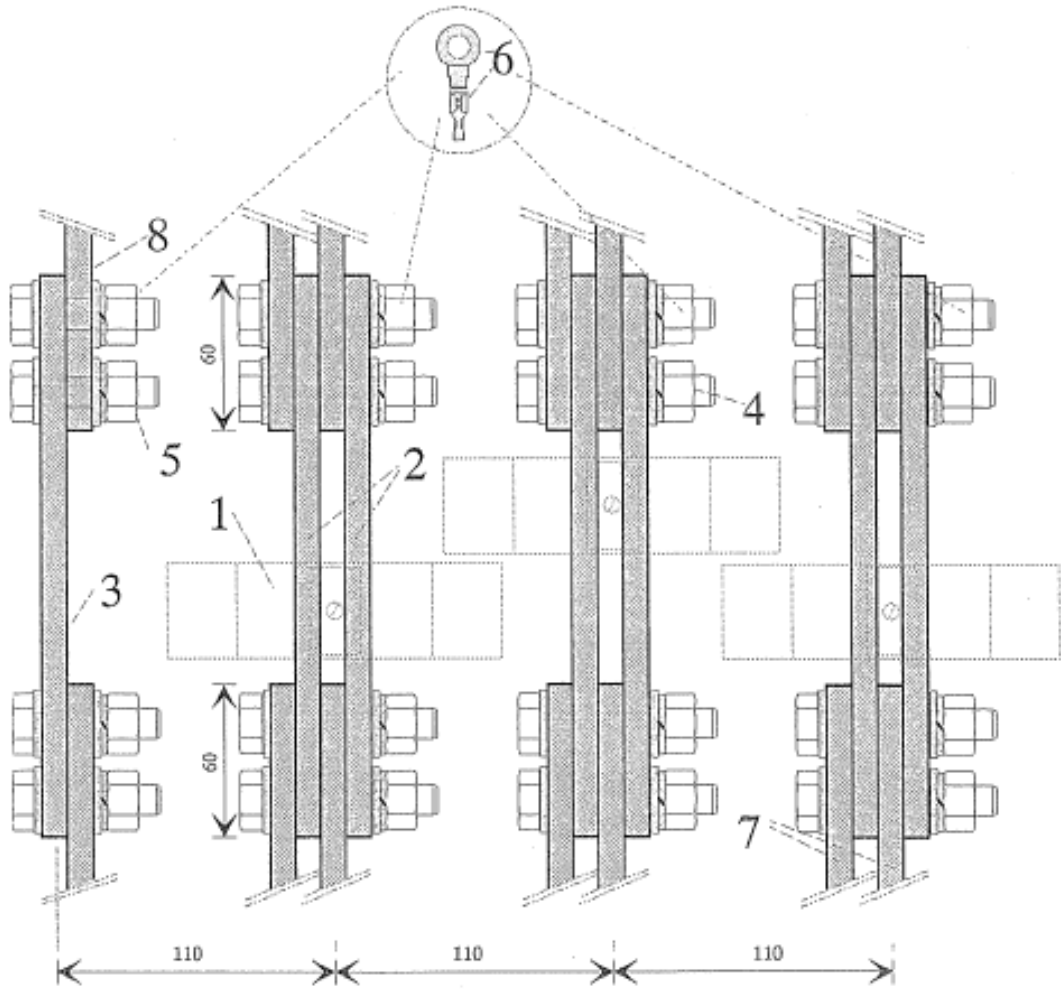

## Apparatus for Type CPTI 200

### Characteristics

Quant.	Pos.	Designation	Characteristics	Observation
3	1	Current transformer	2000/5 A	NCEMC42-301 (provided by CEM)
3	2	Primary busbar of CT	Cu 2x(80x10)	Tinned
1	3	Neutral busbar	Cu 80x10	Tinned
24	4	Hexagonal headed screw M12x70 Hexagonal nut Two washers Spring washer	Mild steel Mild steel Mild steel Steel	Galvanized
8	5	Hexagonal headed screw M12x50 Hexagonal nut Two washers Spring washer	Mild steel Mild steel Mild steel Steel	Galvanized
4	6	Connection terminal	Copper	For connection of conductors of voltage meter
6	7	Connection busbar (phases)	Cu 2x(80x10)	Tinned
2	8	Connection busbar (neutral)	Cu 80x10	Tinned

# Apparatus for Type CPTI 200

Detail  
(dimensions in mm)

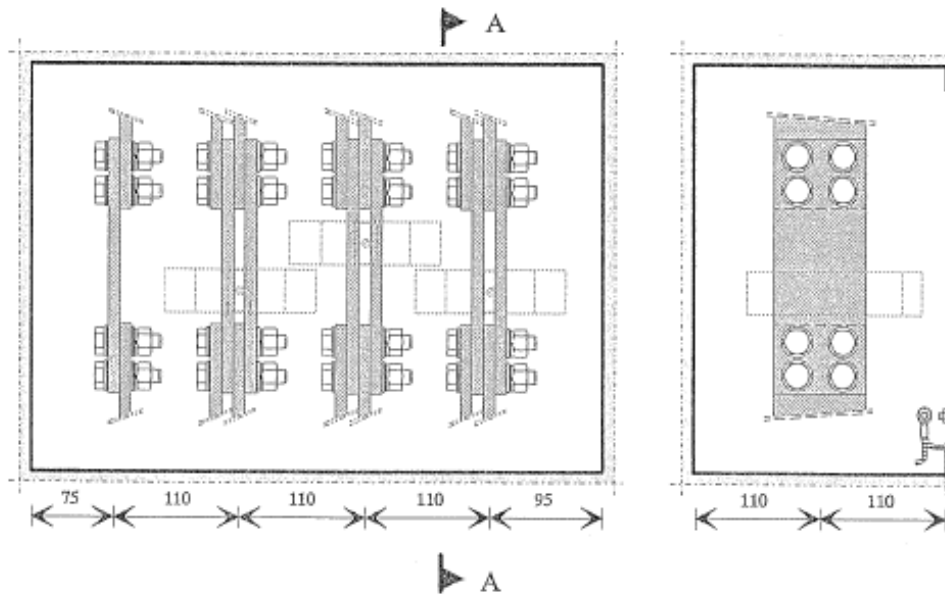
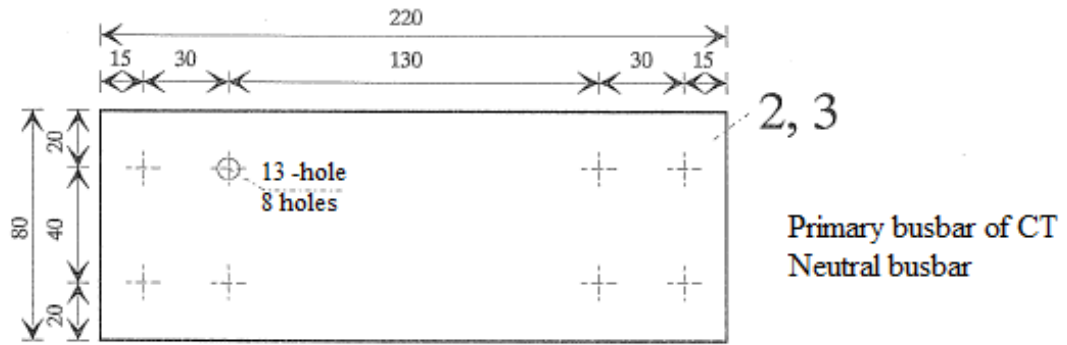

Interior View

Section A-A

# Apparatus for Type CPTI 250

Presentation  
(dimensions in mm)

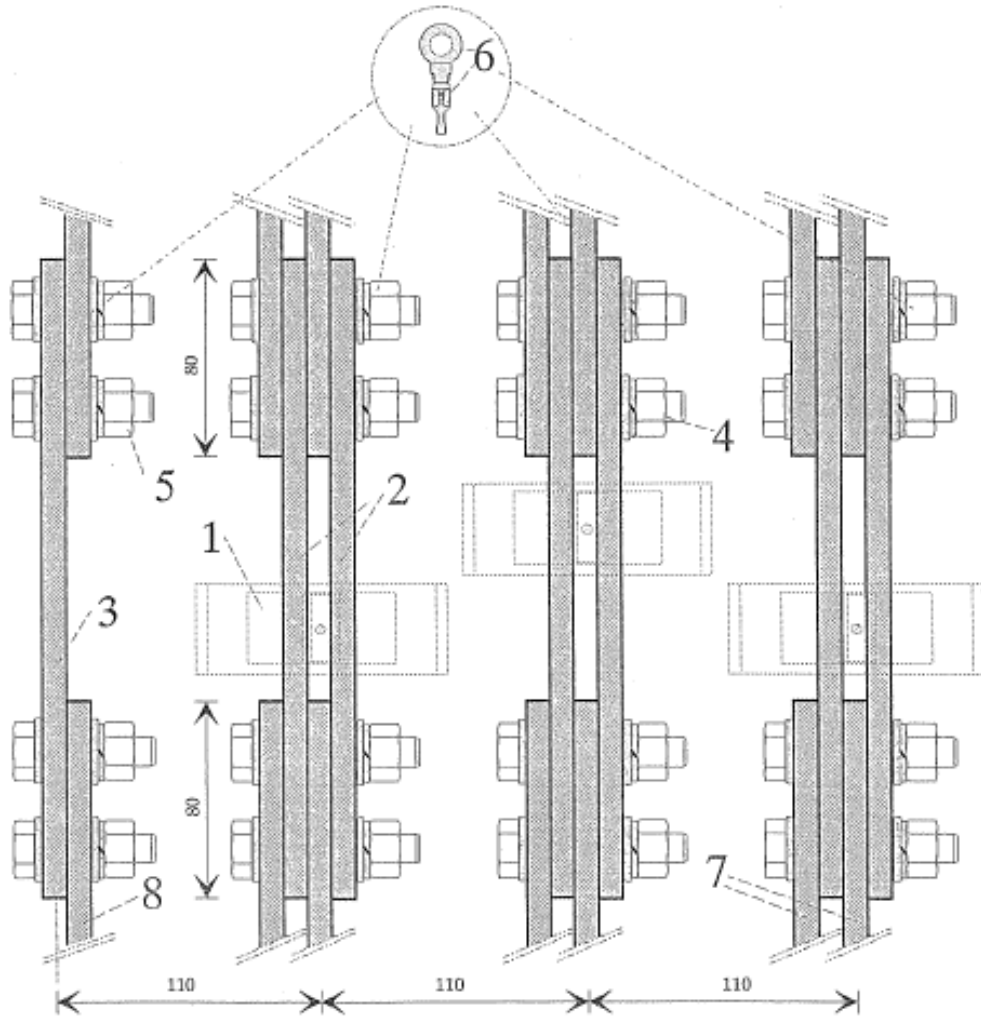

## Apparatus for Type CPTI 250

### Characteristics

Quant.	Pos.	Designation	Characteristics	Observation
3	1	Current transformer	2500/5 A	NCEMC42-301 (provided by CEM)
3	2	Primary busbar of CT	Cu2x(100x10)	Tinned
1	3	Neutral busbar	Cu100x10	Tinned
24	4	Hexagonal headed screw M12x70 Hexagonal nut Two washers Spring washer	Mild steel Mild steel Mild steel Steel	Galvanized
8	5	Hexagonal headed screw M12x50 Hexagonal nut Two washers Spring washer	Mild steel Mild steel Mild steel Steel	Galvanized
4	6	Connection terminal	Copper	For connection of conductors of voltage meter
6	7	Connection busbar (phases)	Cu2x(100x10)	Tinned
2	8	Connection busbar (neutral)	Cu100x10	Tinned

Apparatus for Type CPTI 250

Detail  
(dimensions in mm)

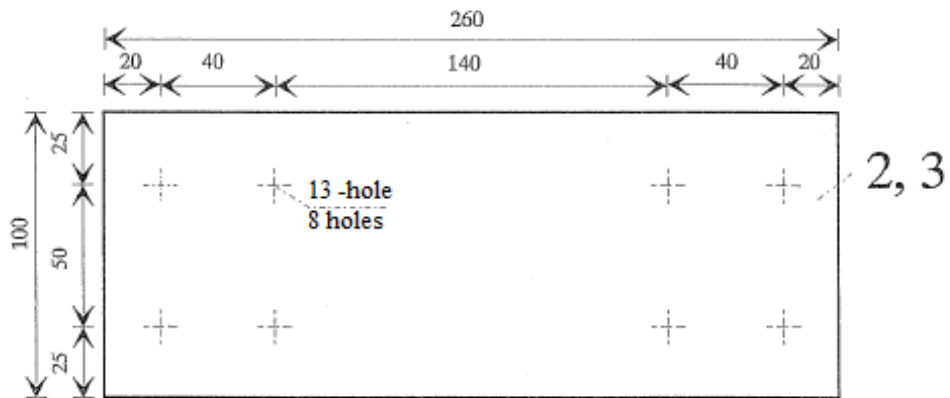

Primary busbar of CT  
Neutral busbar

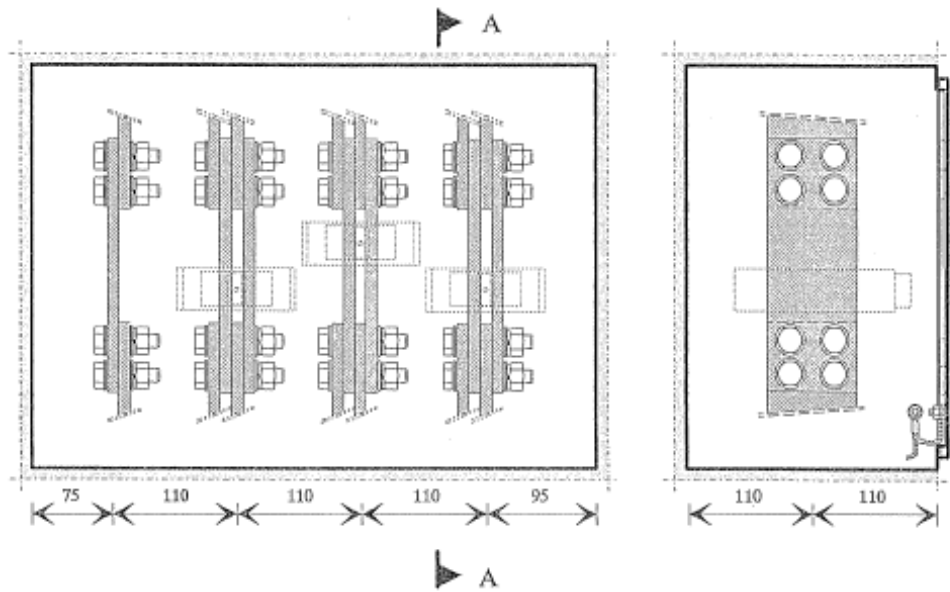

Interior View

Section A-A





# TECHNICAL SPECIFICATION

NCEM C62-321

June 2022

Indoor Meter Box

## Contents

1. Application field .....	3
2. Establishment conditions.....	3
3. Constructive features .....	3
3.1 Generalities .....	3
3.2 Types of boxes .....	3
3.3 Constitution .....	3
3.4 Enclosure.....	4
Type AHC 430 .....	6
Type AVC 300 .....	9

## **1. Application field**

This document defines specifications for boxes for indoor individual energy metering equipment to be used where low voltage electricity is supplied by CEM.

These boxes are briefly referred to as meter boxes.

## **2. Establishment conditions**

The meter boxes shall be installed near the supply point of client's installation, in a suitable location and easily accessible.

Location and environment for meter installation shall comply with the requirements defined in Annex 10.2 of NCEM C14-100.

If the building is located in a low-lying flooding area (as defined by MSAR Government), the installation height of the boxes should meet the requirements defined in Annex 12 of NCEM C14-100.

## **3. Constructive features**

### **3.1 Generalities**

The meter boxes shall be designed and constructed in such a way as to ensure, in normal use, the correct operation of the equipment installed therein and the necessary safety conditions.

### **3.2 Types of boxes**

For the purpose of this section, the following types of meter boxes are considered:

- Type AHC 430 - Horizontal meter box, direct-connected metering;
- Type AVC 300 - Vertical meter box, direct-connected metering;

The meter boxes shall obey the indication in the attached figures, considering that the indicated dimensions are understood as minimum.

### **3.3 Constitution**

The meter boxes consist of 2 different parts:

- a) Enclosure, intended to ensure the protection of the equipment installed therein;

b) Installation plate intended to be used for fixing metering apparatus, and attached to the enclosure in a removable manner.

### 3.4 Enclosure

The enclosure (including the transparent glass window) shall be flame retardant and should have the shape and dimensions shown in the attached figures and be constructed of:

- a) Plywood board with a minimum 12mm thickness for direct-connected metering;
- b) Galvanized sheet steel, with a minimum 1.5 mm thickness a galvanizing thickness of not less than 20  $\mu\text{m}$ , for indirect-connected metering;

Type of Box	Enclosure		
	Width	Height	Depth
AHC 430	430	380	230
AVC 300	300	540	230

- Characteristics of metal enclosures

The metal enclosure shall be protected against corrosion by observing the following:

- A zinc-rich primer coating (zinc powder or zinc chromate), a wash-primer coating and a finish enamel coating should be applied successively to the carefully cleaned and degreased sheet. A coating of finish marine type enamel shall be applied (Transocean Marine Paint, Hammer-Tone finish, color 916-05, or equivalent type from another manufacturer, but of similar color).

The hinges, bolts, nuts and washers shall preferably be of stainless material or be protected against corrosion by galvanizing or electrolytic plating of a minimum 12  $\mu\text{m}$  thickness applied prior to assembly. After assembly, all screws should be painted with a finish coating.

The opening for passage of electrical conduits should be painted, immediately after its execution, with a coat of primer of the type used in the painting of the meter box.

The passage of the electrical conduits will be carried out using nozzles or stoppers for tube, according to cross-sections of tube, and in thermoplastic material. For multicore cable, it will be carried out using cable glands of suitable diameter.

- Characteristics of Wood Enclosures

The external surface of the wooden enclosure should be protected with paint finish, according to building architecture.

Iron hinges, handles and screws shall be protected against corrosion by galvanizing or electrolytic plating, with a minimum 12 µm thickness.

- Installation plate

The installation plate should have the shape and dimensions shown in the attached figures and be constructed of bakelite plate with 5 mm thickness.

- Energy metering equipment (to be supplied and installed by CEM)

- a) For direct-connected metering

- Service circuit breaker for limiting contracted apparent power
- Single phase or three-phase active energy meter

- b) For indirect-connected metering

- Simple rates (Group A)

- Three-phase active energy meter

- Double rates (Group B and C)

- Three-phase energy meter
- Terminal strip

Horizontal meter box, direct-connected metering  
Type AHC 430

Invólucro  
(dimensões em mm)

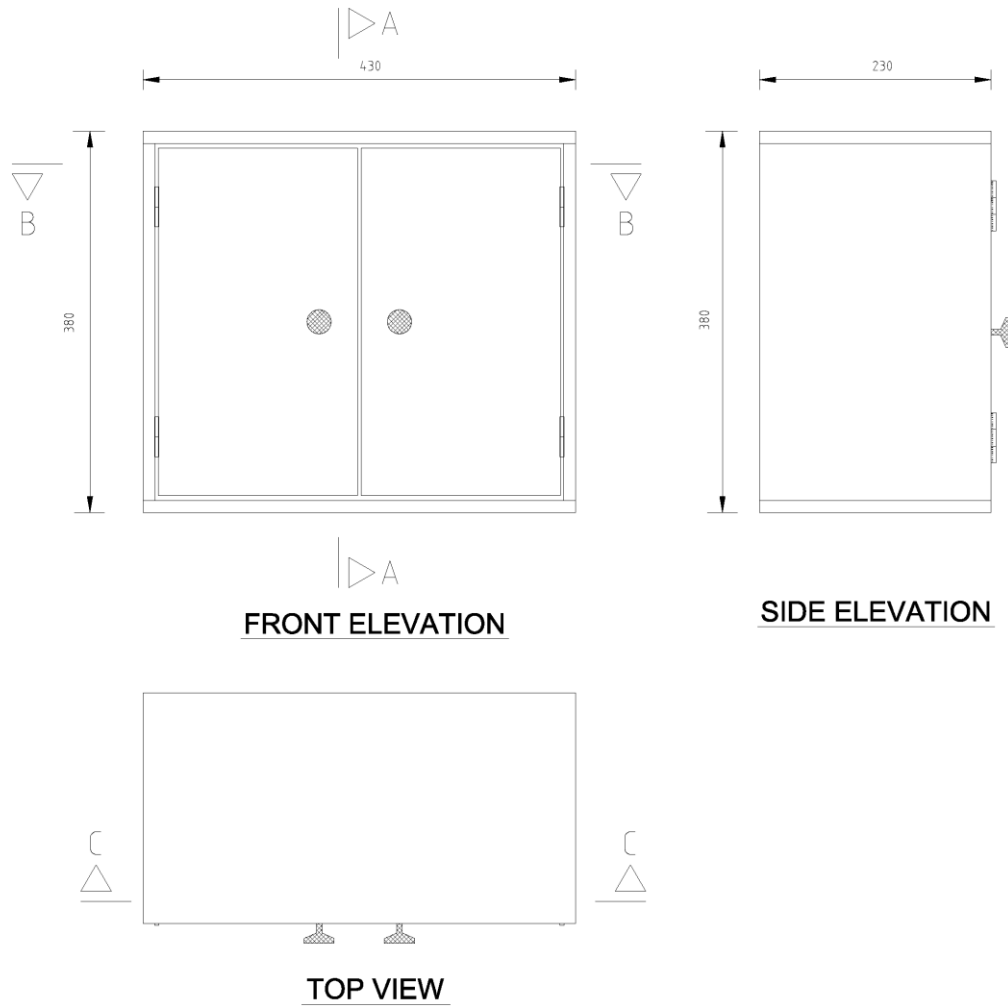

Type AHC 430  
Enclosure  
(dimensions in mm)

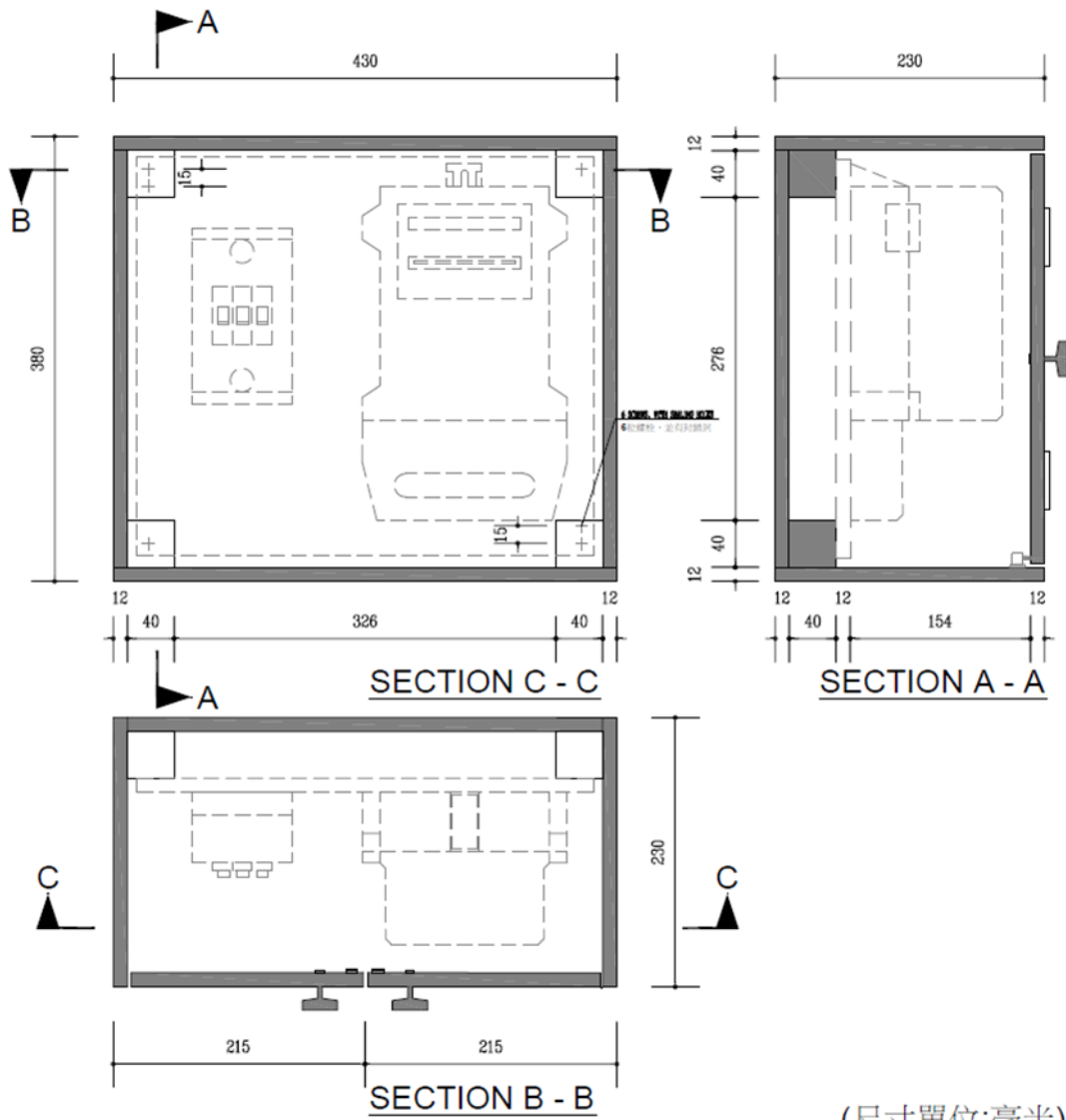

(尺寸單位:毫米)

# Type AHC 430

## Installation plate (dimensions in mm)

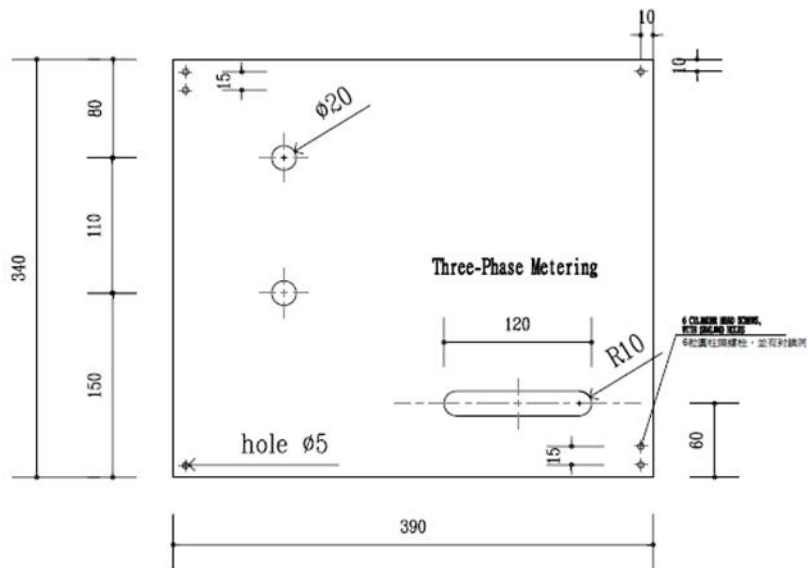
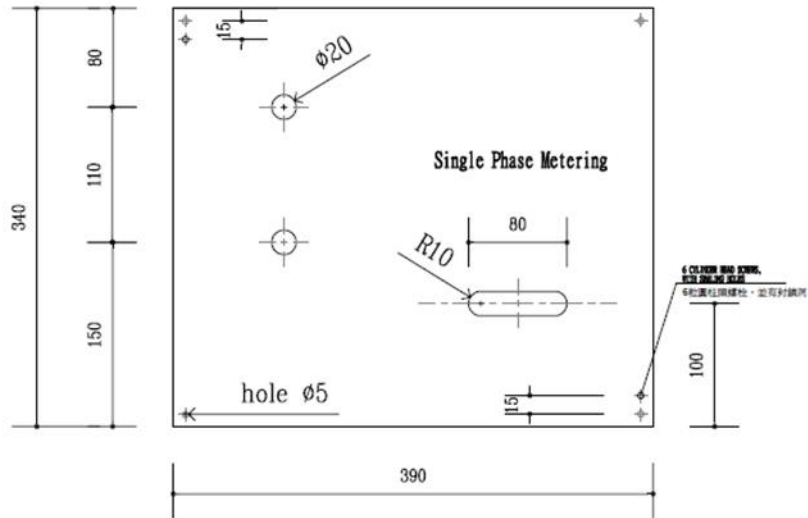

(尺寸單位:毫米)



Vertical meter box, direct-connected metering  
Type AVC 300

Enclosure  
(dimensões em mm)

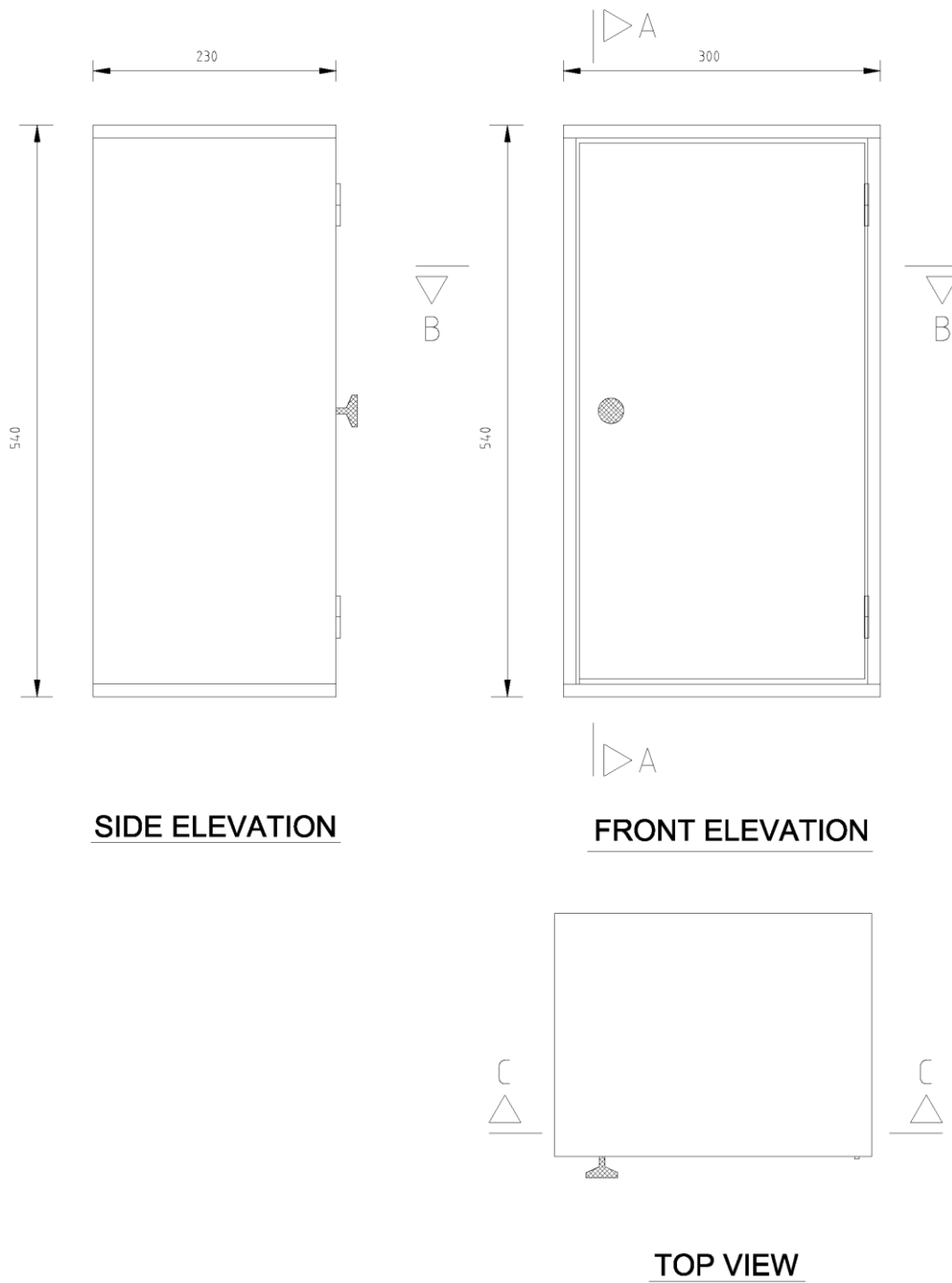

Type AVC 300

Enclosure  
(dimensions in mm)

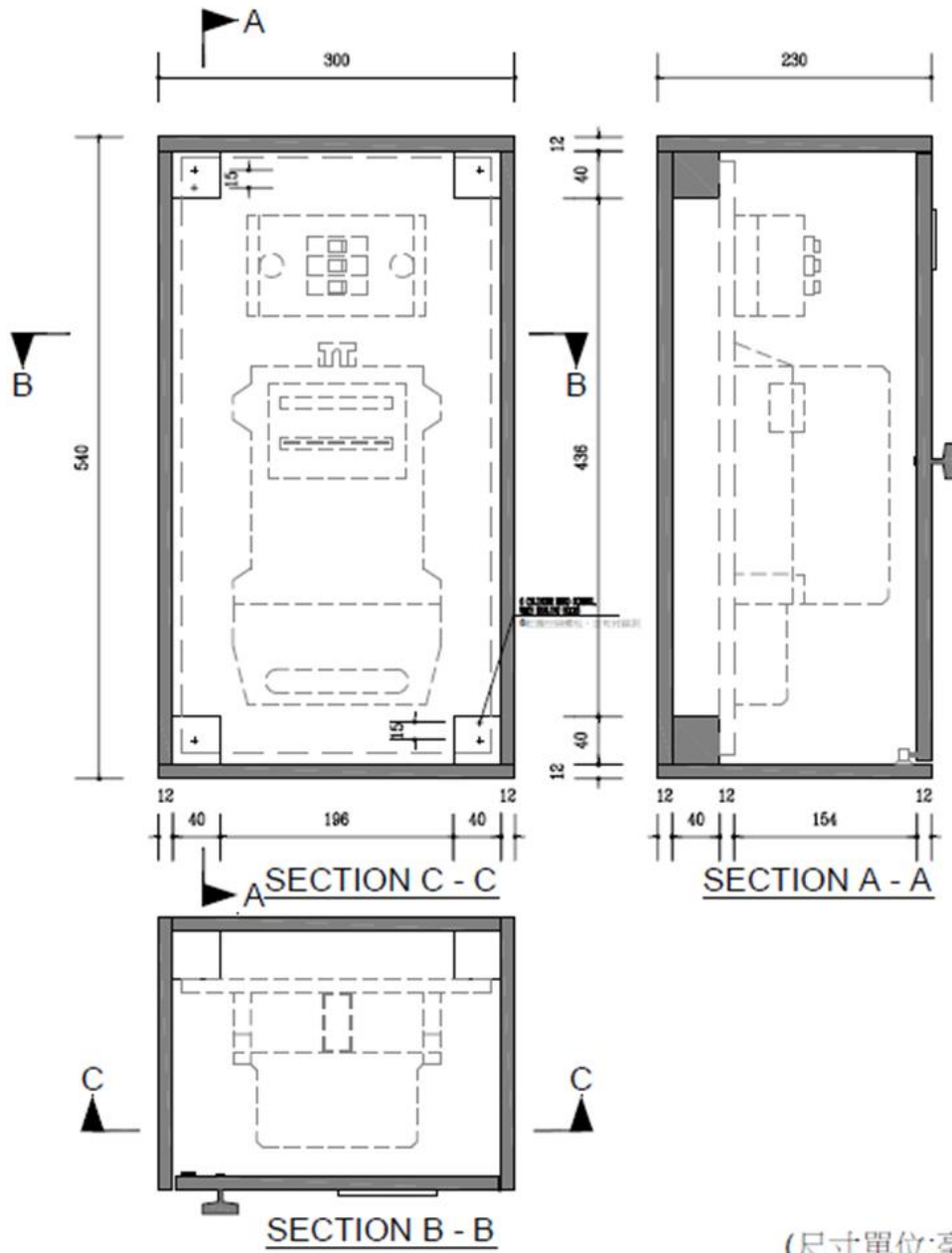

Type AVC 300

Installation plate  
(dimensions in mm)

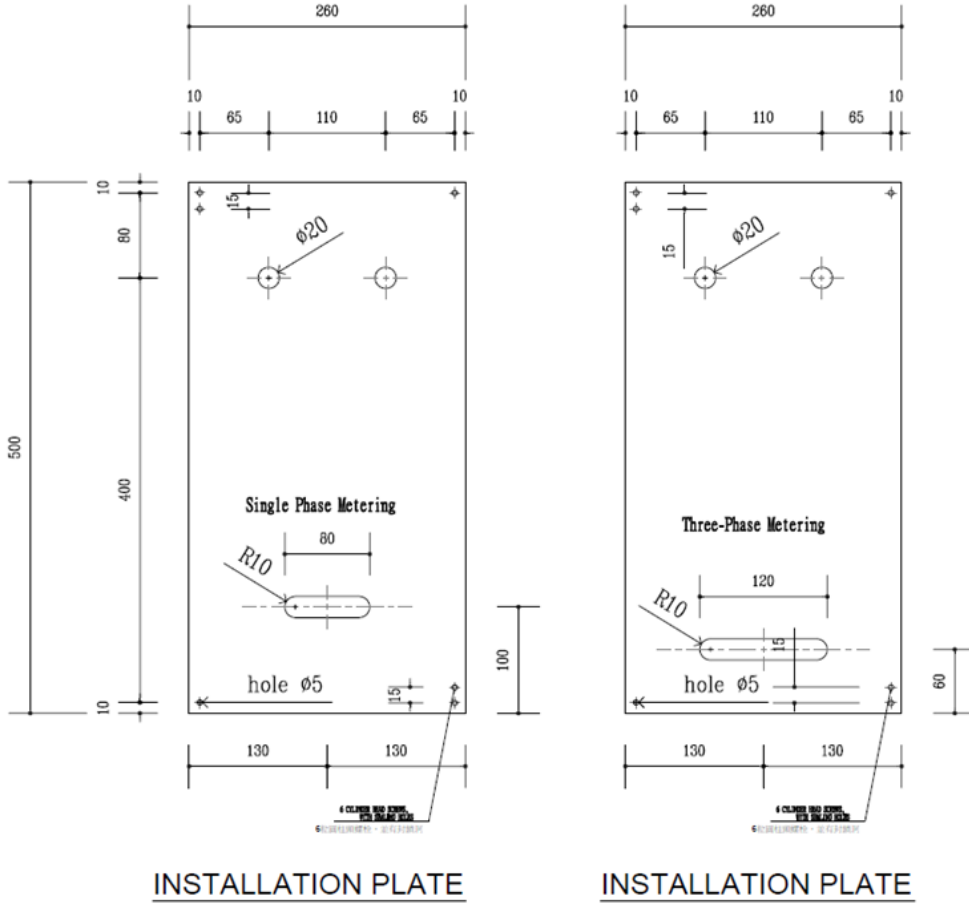

INSTALLATION PLATE

INSTALLATION PLATE

(尺寸單位:毫米)



# TECHNICAL SPECIFICATION

NCEM C62-322

June 2022

Individual Metering Boards

## Contents

1. Application field.....	3
2. Establishment conditions .....	3
3. Constructive features.....	4
3.1 Generalities .....	4
3.2 Types of boards.....	4
3.3 Constitution.....	4
3.4 Energy metering equipment.....	5
Type PHCM 300.....	6
Type PVCM 200 .....	7
Type PHCT 350.....	8
Type PVCT 250 .....	9
Meter board mounting in niche .....	10
Meter board mounting in vertical duct .....	11

## 1. Application field

This document defines specifications for individual direct metering to be used where low voltage electricity is supplied by CEM.

These boards are briefly referred to as meter boards.

## 2. Establishment conditions

The meter boards shall be installed inside the buildings, near the supply point of client's installation, in a suitable location and easily accessible.

The meter boards of the client's installation for the same building may be installed:

a) In appropriate spaces in common areas of collective use, together with meter boards of the premises of each floor, in the case of autonomous units of residential and commercial buildings;

b) In appropriate spaces in common areas of collective use, together with meter boards of the premises of each floor or group of incomings, in the case of autonomous units of industrial buildings and shopping centers;

Appropriate spaces for the installation of meter boards are described as follows:

- Niches with a door, intended for the installation of meters for the client's installations of each floor or group of incomings;

- Vertical ducts with a door, intended for the installation of risers, collective line distribution boxes and meters corresponding to the installations of each floor;

The characteristics and dimensions of vertical niches and ducts for metering installation shall be defined taking account of the following:

a) The front configuration of niches and ducts shall be rectangular and result from the overlap of meter boards;

b) The access door shall open outwards, shall not be able to open inwards, and shall include a handle on its outer portion;

- c) The depth of the space of niches and ducts, for housing of meter board and respective equipment, should be at least 0.22 m;
- d) The access dimensions of niches and ducts shall be at least equal to the outer dimensions of meter board set plus 0.10 m, in order to ensure a distance of 0.05 m (measured in vertical projection) to the meter board set;
- e) The meter boards shall be installed such that the meter display is not less than 0.7 m or more than 1.7 m above the floor. If the building is located in a low-lying flooding area (as defined by MSAR Government), the installation height should meet the requirements defined in Annex 12 of NCEM C14-100.

The attached figures give examples of the arrangement of meter boards in niches and vertical ducts. These examples are not restrictive.

### **3. Constructive features**

#### **3.1 Generalities**

The meter boards shall be designed and constructed in such a way as to ensure, in normal use, the correct functioning of the equipment installed therein and the necessary safety conditions.

The meter boards shall be made of bakelite.

#### **3.2 Types of boards**

For the purposes of this section, the following types of meter boards are considered:

- Type PHCM 300 - Horizontal single-phase meter board;
- Type PVCM 200 - Vertical single-phase meter board;
- Type PHCT 350 - Horizontal three-phase meter board;
- Type PVCT 250 - Vertical three-phase meter board;

#### **3.3 Constitution**

The meter boxes are made up of two different parts:

- a) Base for the installation of energy metering equipment;
- b) Frame for fixing the base in a removable manner.

The bases for installing metering equipment shall be of the shape and dimensions indicated in the enclosed figures and in the below table, and shall be made of a 5 mm thickness bakelite plate.

<b>Type of board</b>	<b>Width</b>	<b>Height</b>
PHCM 300	300	300
PVCM 200	200	400
PHCT 350	350	350
PVCT 250	250	500

The frames should have the shape and dimensions indicated in the enclosed figures and should be made of pine wood or similar.

### **3.4 Energy metering equipment**

The meter boards are intended to contain the metering equipment, supplied and assembled by CEM, consisting of:

- a) Single phase meter board
  - Service circuit breaker for limiting contracted apparent power;
  - Single phase energy meter;
  
- b) Three-phase meter board
  - Service circuit breaker for limiting contracted apparent power;
  - Three-phase energy meter.



### Horizontal single-phase meter board

Type PHCM 300  
(dimensions in mm)

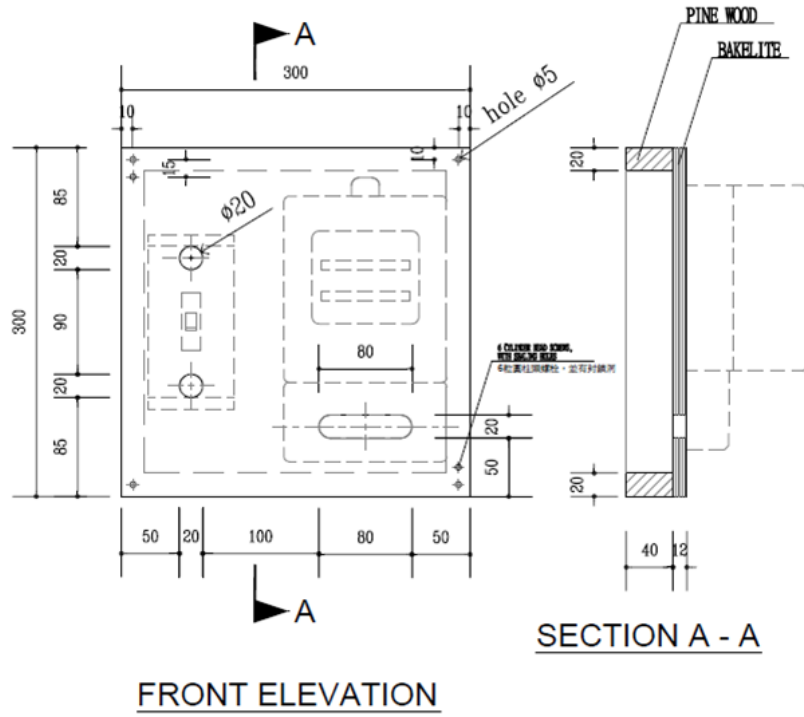

(尺寸單位:毫米)

### Vertical single-phase meter board

Type PVCM 200  
(dimensions in mm)

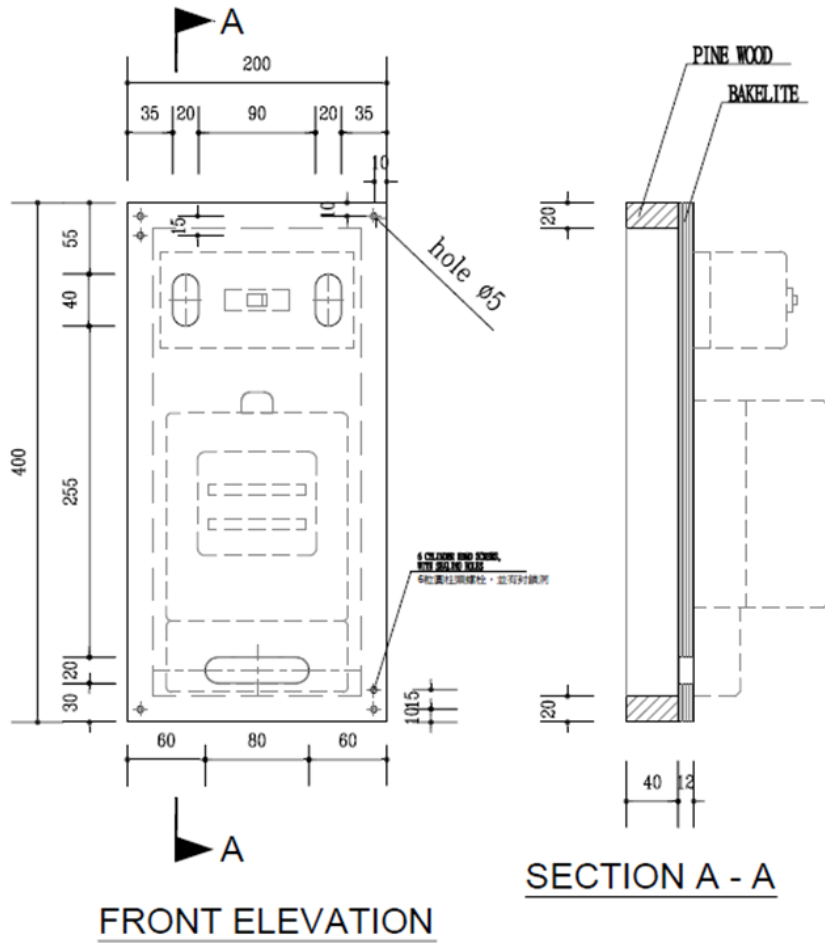

(尺寸單位:毫米)

### Horizontal three-phase meter board

Type PHCT 350  
(dimensions in mm)

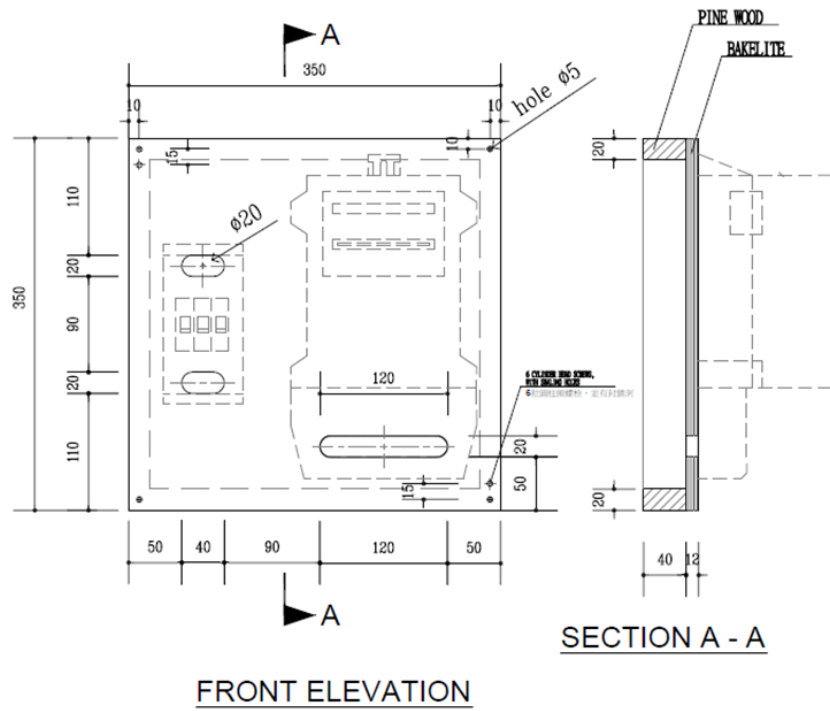

(尺寸單位:毫米)

### Vertical three-phase meter board

Type PVCT 250  
(dimensions in mm)

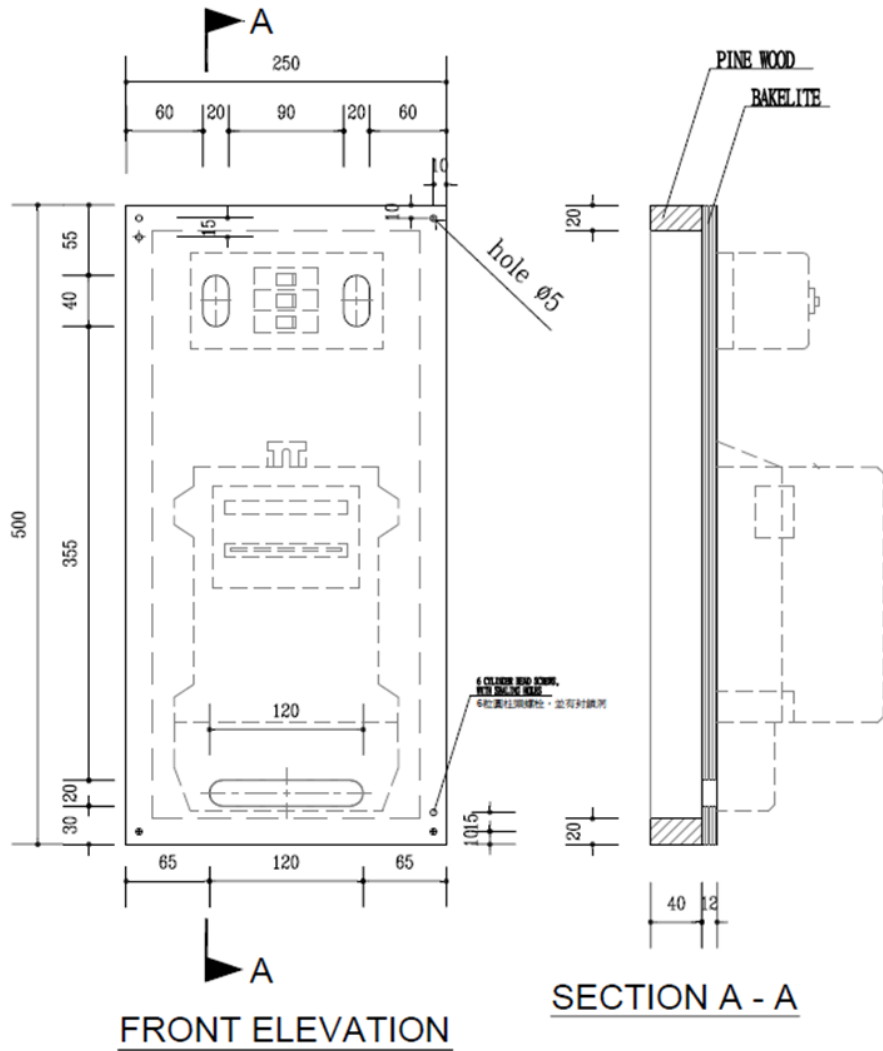

(尺寸單位:毫米)

### Meter board mounting in niche

(dimensions in mm)

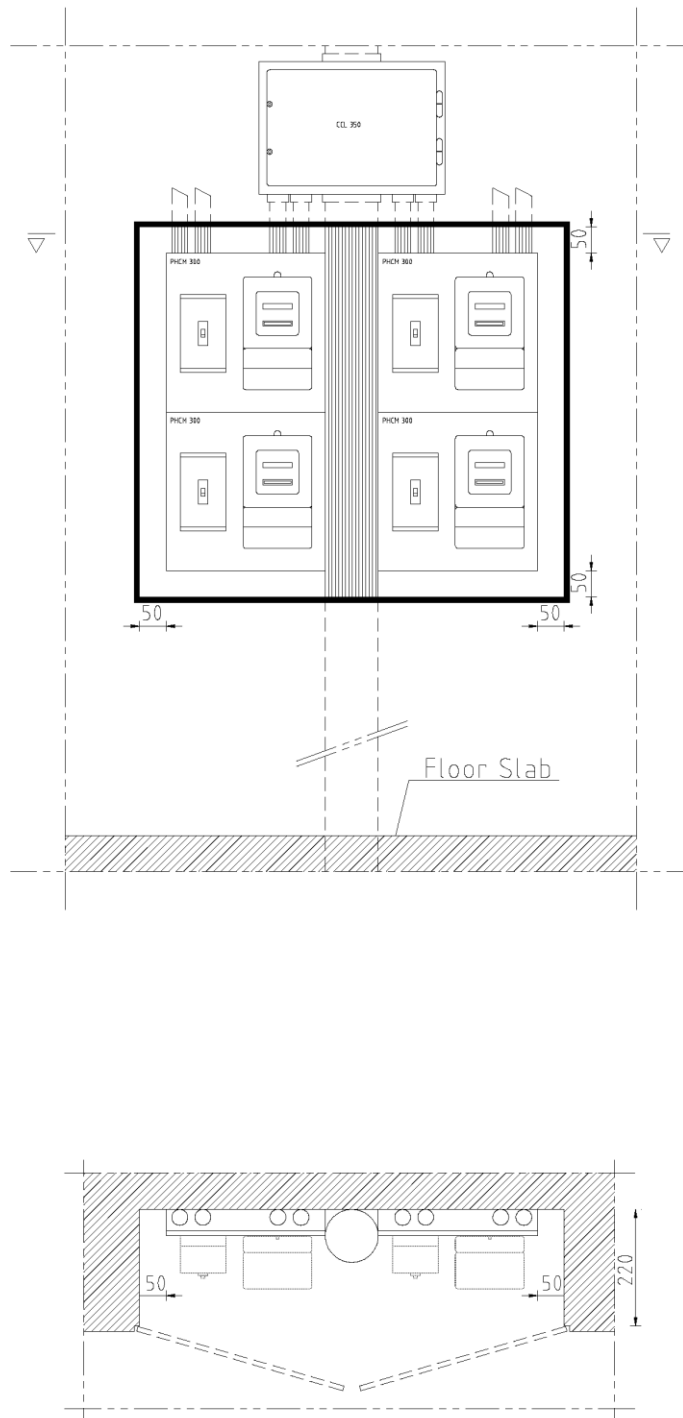

### Meter board mounting in vertical duct (dimensions in mm)

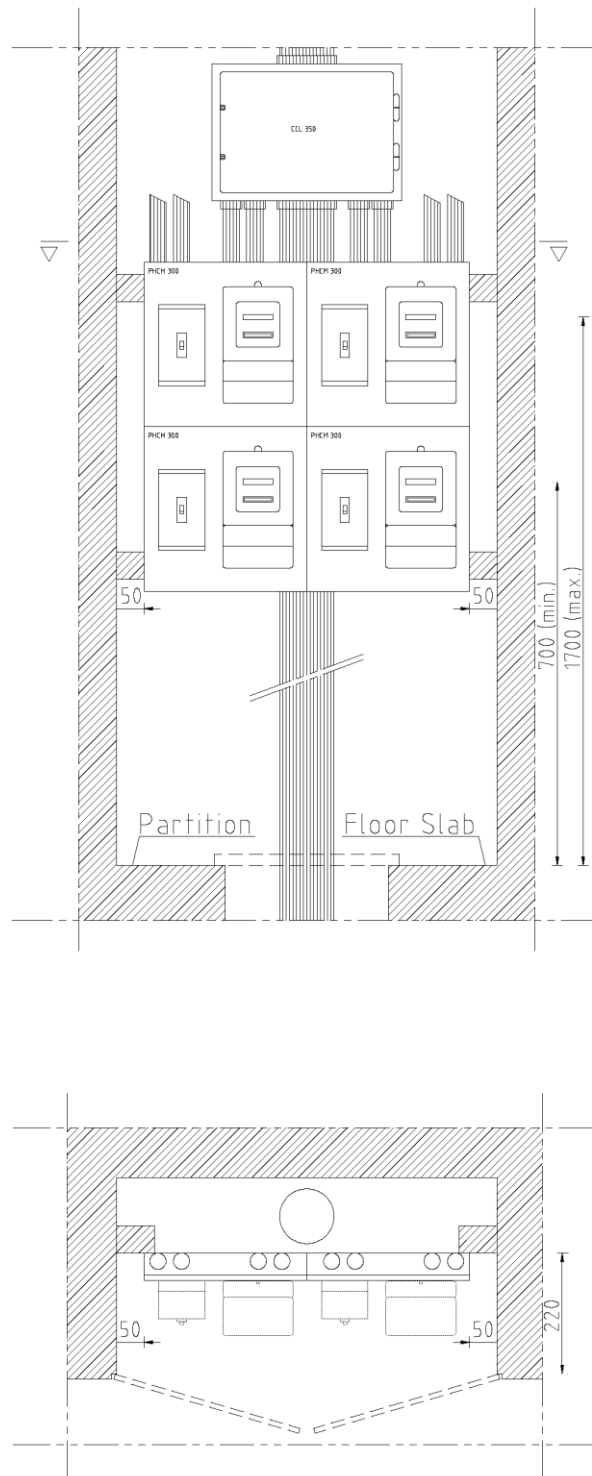



# TECHNICAL SPECIFICATION

NCEM C62-323

June 2022

Outdoor Meter Box

## Contents

1. Application field .....	3
2. Establishment conditions.....	3
3. Constructive features .....	3
3.1 Generalities .....	3
3.2 Types of boxes .....	3
3.3 Constitution .....	4
3.4 Energy metering equipment.....	6
Type ACX .....	7



## 1. Application field

This document defines specifications for boxes for indoor individual energy metering equipment to be used where low voltage electricity is supplied by CEM.

These boxes are briefly referred to as meter boxes.

## 2. Establishment conditions

The meter boxes shall be installed near the supply point of client's installation, in a suitable location and easily accessible.

The meter boxes of client's installation of the same building may be installed:

a) Outside the building, on the façade of building or on the property's fencing wall near the respective incoming, adjacent to public road or public domain access, in the case of single-family residential buildings;

b) Outside the building, on the façade of the building near the respective incoming, adjacent to public road or public domain access, in the case of buildings or autonomous units intended for commercial or industrial activities;

The meter boxes shall be installed so that the meter display is not less than 1 m or more than 1.70 m above the floor. If the building is located in a low-lying flooding area (as defined by MSAR Government), the installation height of the boxes should meet the requirements defined in Annex 12 of NCEM C14-100.

## 3. Constructive features

### 3.1 Generalities

The meter boxes shall be designed and constructed in such a way as to ensure, in normal use, the correct operation of the equipment installed therein and the necessary safety conditions.

### 3.2 Types of boxes

For the purpose of this section, the following type of meter boxes is considered:

- Type ACX - Outdoor box for direct and indirect connected metering;

The meter boxes shall be in accordance with the attached figures and the table below.

Type of Box	Enclosure		
	Width	Height	Depth
ACX	360	540	230

### 3.3 Constitution

The meter boxes consist of two different parts:

a) Enclosure, intended to ensure the protection of the equipment installed therein, composed of:

- One tub box;
- One cover or a door fitted with a closing device;

b) Installation plate intended for installing metering equipment, to be attached to the enclosure in a removable manner.

- Enclosure

The enclosure (including the transparent glass window) shall be flame retardant and should be constructed of polyester reinforced with glass fiber or other insulating plastic material with appropriate characteristics, in particular:

- a) Be flame retardant
- b) Be sufficiently stable after exposing to weather conditions under normal conditions.

- Degree of protection

The enclosure shall be designed and constructed in such a way that it will not suffer any permanent deformation and permit adequate ventilation of the electrical equipment in order to avoid possible condensation, with IP43 and IK09 protection rating as defined in IEC 60529 and IEC 62262 respectively.

- Protection against corrosion

All iron parts incorporated in enclosure should preferably be of stainless steel or be effectively protected against corrosion by galvanizing and passivation.

The enclosure shall resist the corrosion of ultraviolet rays.

- Equipment mounting

The enclosure shall be fitted with a M6 threaded bolt for fastening the installation plate.

- Opening for passage of electrical conduits

The opening for passage of electrical conduits should be painted, immediately after its execution, with a coat of primer of the type used in the painting of the boxes.

- Interior accessibility

The enclosure shall be provided with a cover or door, provided with windows in transparent insulation material for meter reading in accordance to attached figure (Minimum size shall be 25cm length with 20cm wide). The locking system of the enclosure, when fitted with a cover, shall be made by 8 mm triangular head screw(s). When equipped with a door, it shall be made by a lockable handle with 8 mm triangular female socket wrench, fitted with a sealing device.

- Marking

The enclosure should have an indelible and well legible marking, consisting of the manufacturer's identification and the protection index.

- Polyester enclosure

The attached figures provide information of polyester enclosures, which are currently used for meter boxes and approved by CEM.

Models from other manufacturers may be considered subject to prior approval by CEM.

- Installation plate

The installation plate should have the shape and minimum dimensions indicated in the attached figures, and be constructed of bakelite plate with a 5 mm thickness.

### **3.4 Energy metering equipment**

The meter boxes are intended to contain the metering equipment, supplied and assembled by CEM, consisting of:

- Single or three-phase active energy meter;

#### Simple rates (Group A)

- Three-phase energy meter;

#### Double rates (Group B and C)

- Single phase energy meter, multi-rates with maximum indication;
- Three-phase energy meter, multi-rates with maximum indication;
- Terminal strip

### Type ACX

Outdoor meter box for direct and indirect-connected metering

Enclosure  
(dimensions in mm)

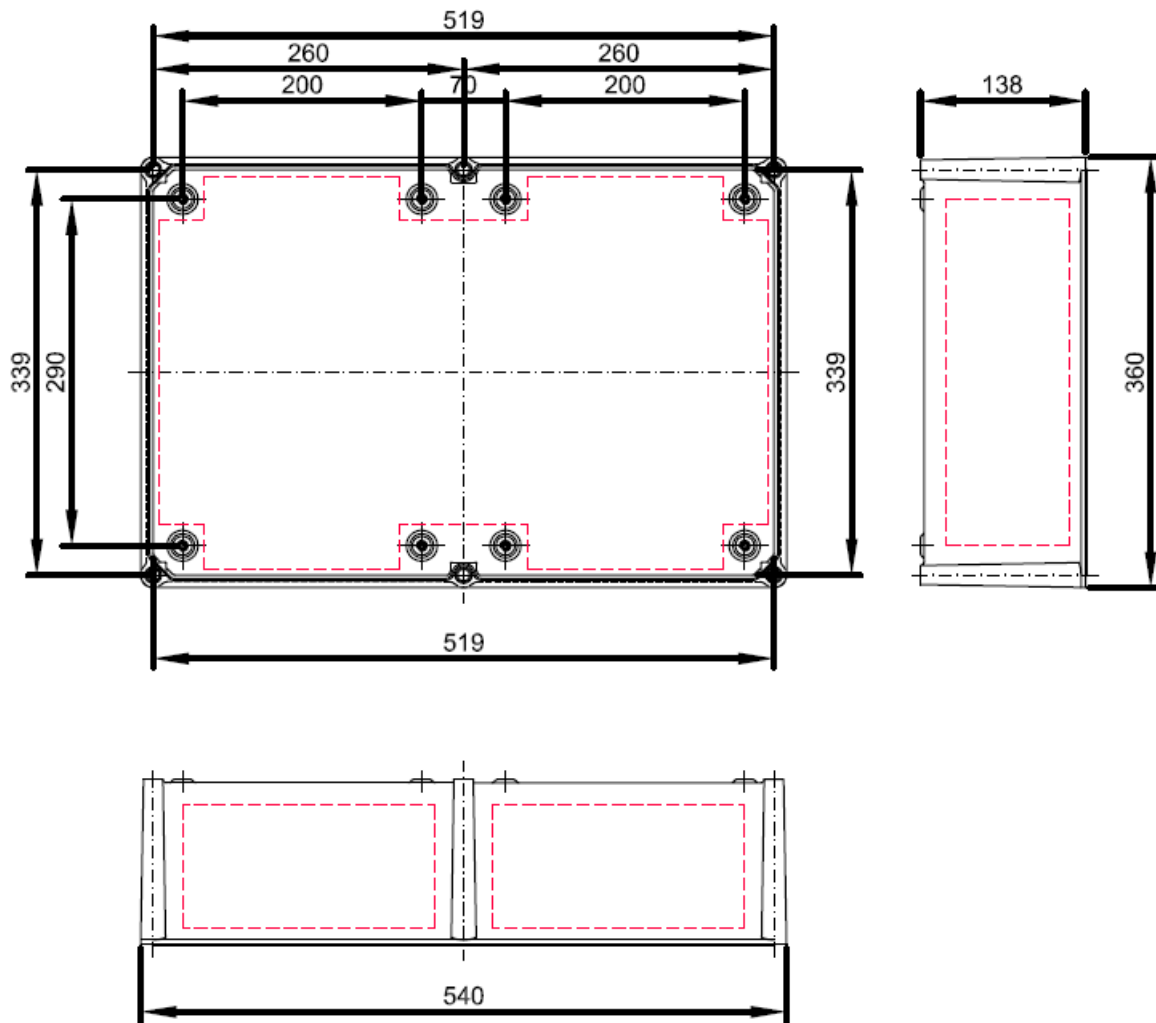

**Type ACX**  
Outdoor meter box for direct and indirect-connected metering

Cover  
(dimensions in mm)

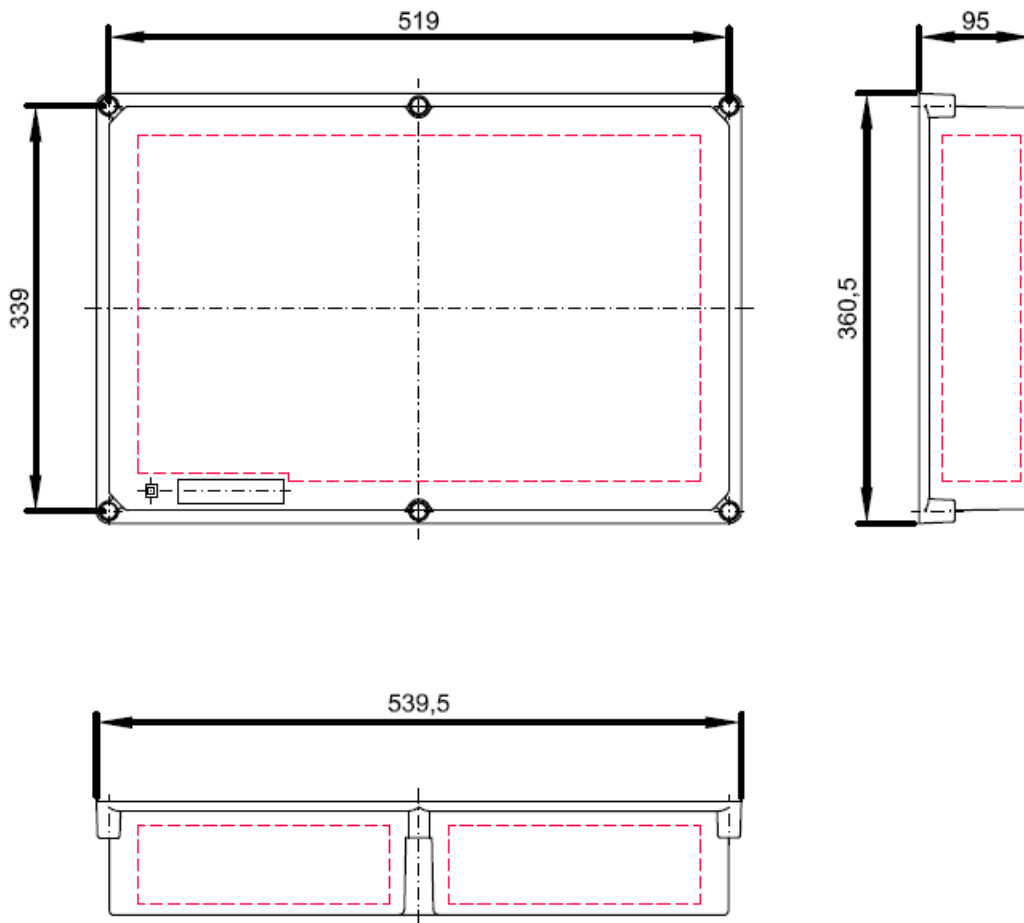

### Type ACX

Outdoor meter box for direct and indirect-connected metering

Installation plate  
(dimensions in mm)

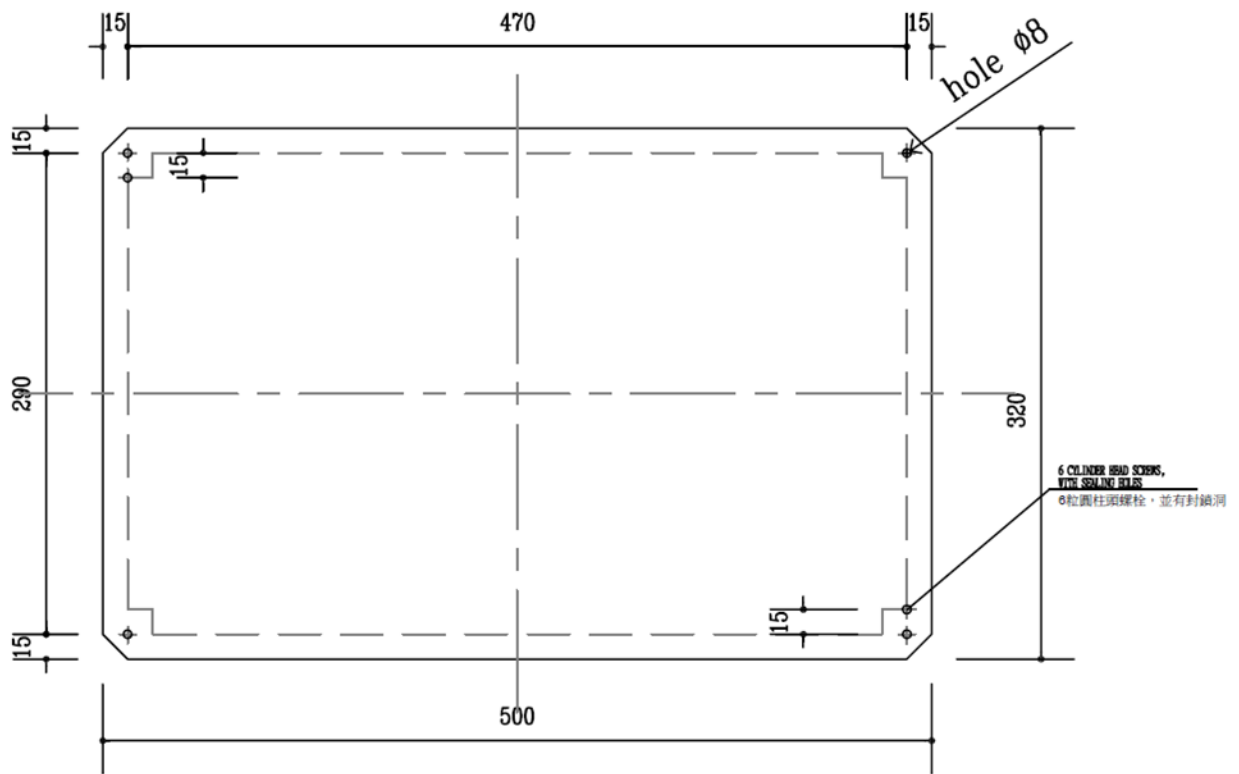

(尺寸單位:毫米)